

1 Parts in this Box
Pièces dans cette boîte

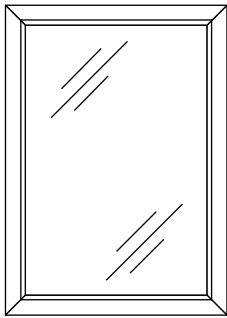

Mirror x 1

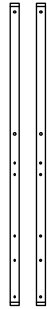

Rails x 2

2 Hardware in this box
Quincaillerie incluse

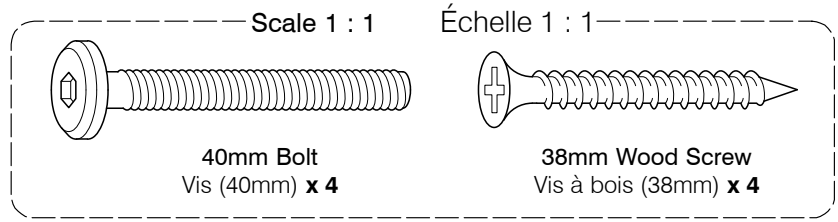

40mm Bolt
Vis (40mm) x 4

38mm Wood Screw
Vis à bois (38mm) x 4



Spring Washer
Rondelle À ressort x 4



Flat Washer
Rondelle plate x 4



Allen Key
Clef allen x 1

3 Assembly to the Secrets2 7 Drawer dresser
Assemblage sur la commode 7 tiroirs "Secrets2"

This is a two person job:-
Placed the Mirror on top of the dresser and screw the Rails to the Dresser Back (Total 4).

Ceci est un travail pour deux personnes:-
Placer le miroir sur le dessus de la commode et visser les rails au derriere de la commode (4 en tous).

Afterwards the Dresser should be placed against a wall for support.

Ensuite le bureau doit être placé contre un mur pour être supporté.

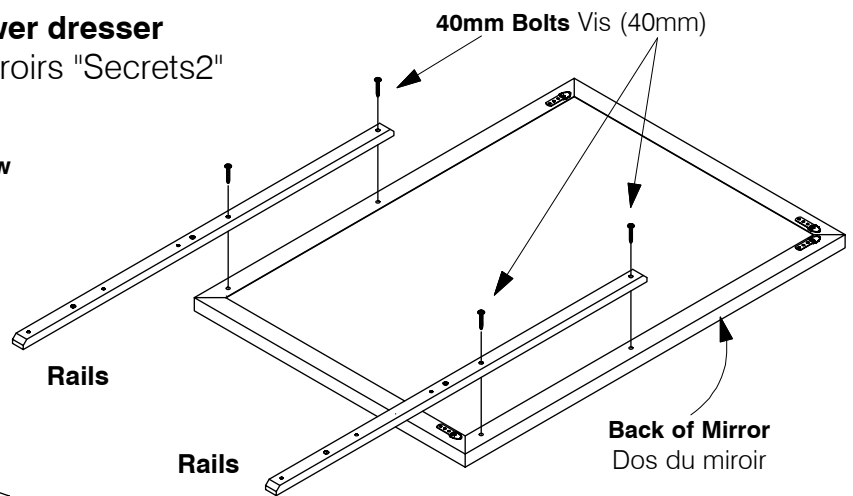

Rails

Rails

Back of Mirror
Dos du miroir

Use 2 People!

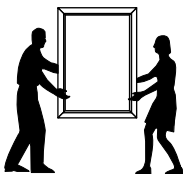

Il faut être
2 personnes!

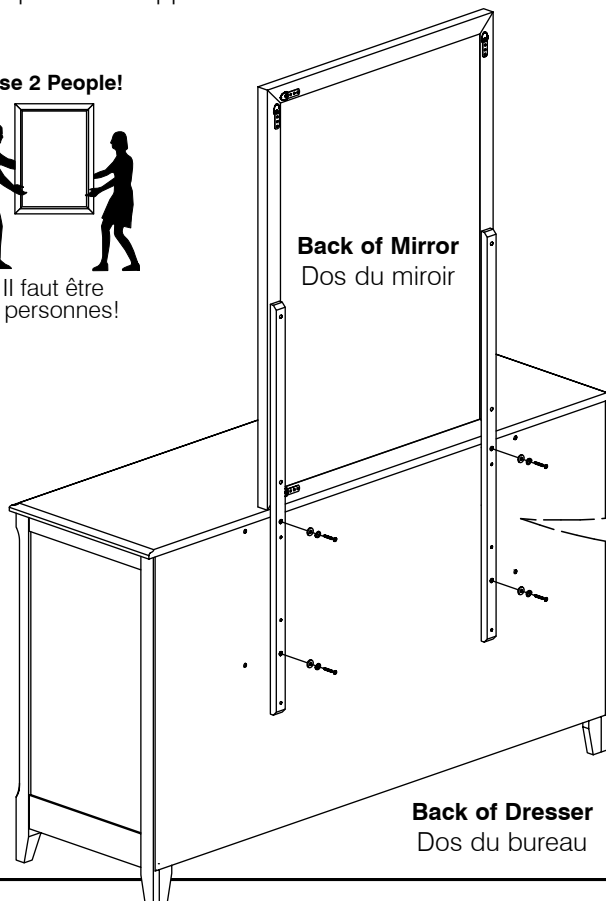

Back of Mirror
Dos du miroir

Back of Dresser
Dos du bureau

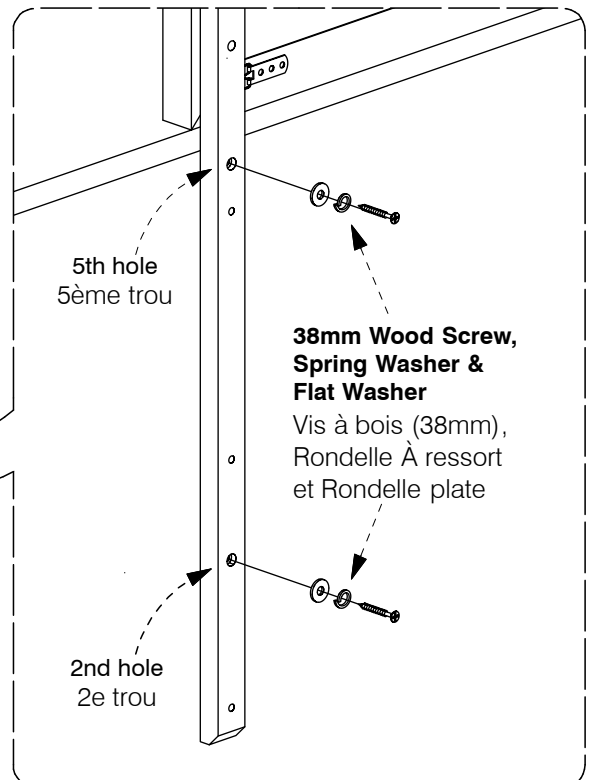

5th hole
5ème trou

2nd hole
2e trou

**38mm Wood Screw,
Spring Washer &
Flat Washer**
Vis à bois (38mm),
Rondelle À ressort
et Rondelle plate