

### 1 Parts in this Box / Pièces dans cette boîte:

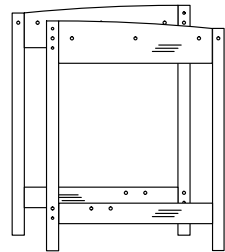

Side Panels /  
Panneau de côté x 2

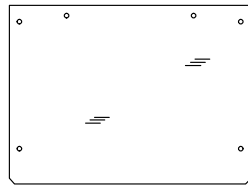
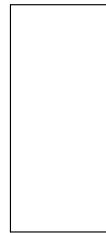
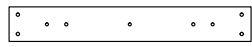

Table Top /  
Dessus de table x 1



Drawer Bottom /  
Fond de tiroir x 1



Top Rail / Rail du haut  
x 1

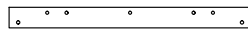

Bottom Rail /  
Rail du arrière x 1

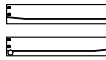

Side Panel /  
Panneau de côté x 2  
(for Drawer / pour tiroir)

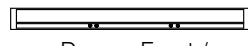

Drawer Front /  
Panneau frontal x 1

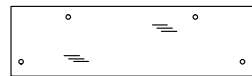

Shelf / Tablette  
x 1

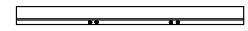

Drawer Back /  
Panneau arrière x 1

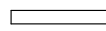

Support /  
Support x 2

### 2 Hardware in this Box / Quincaillerie incluse:



90mm Bolts /  
Vis (90mm) x 6



Long Allen Key /  
Longue clef allen x 1



Minifix Housing /  
Raccordement pour le  
rangement x 10



Nylon Socket /  
Douille en nylon  
x 10



10mm Wood  
Dowels / Goujons  
de bois x 16



6mm Wood  
Dowels / Goujons  
de bois x 12



Connecting Bolt /  
Vis pour raccordement  
x 10

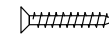

25mm Wood  
Screws / Vis à bois  
(25mm) x 12



Barrel Nuts /  
Écrous x 6

**Please Note: Do not assemble using power tools. This can cause the bolts to be overtightened**

**A Noter: Ne pas assemblé avec de l'outillage a puissance. Cela peut causer les boulons a être trop serré.**

### 3 Assemble the Drawer / Assembler le tiroir.

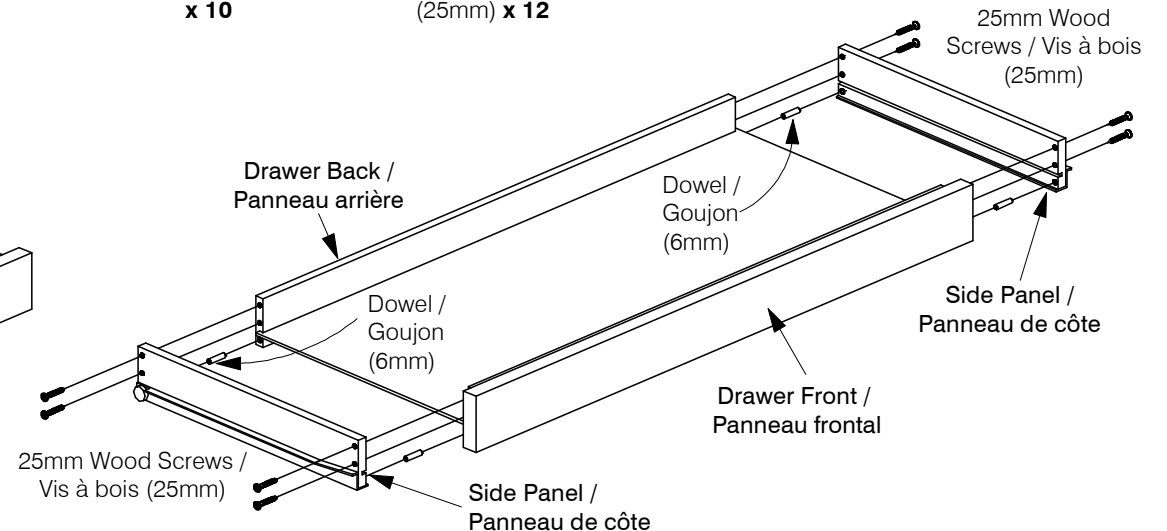
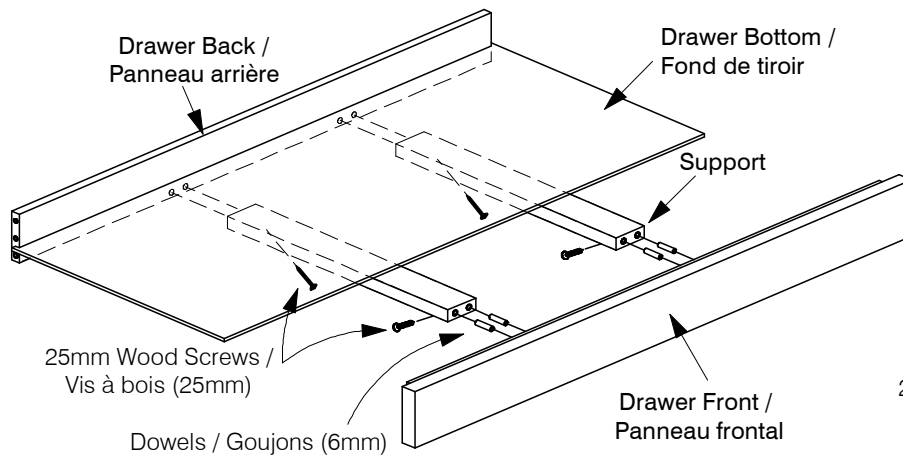

**4 Assemble the Shelf & Table Top / Assembler la tablette et le dessus de la table.**

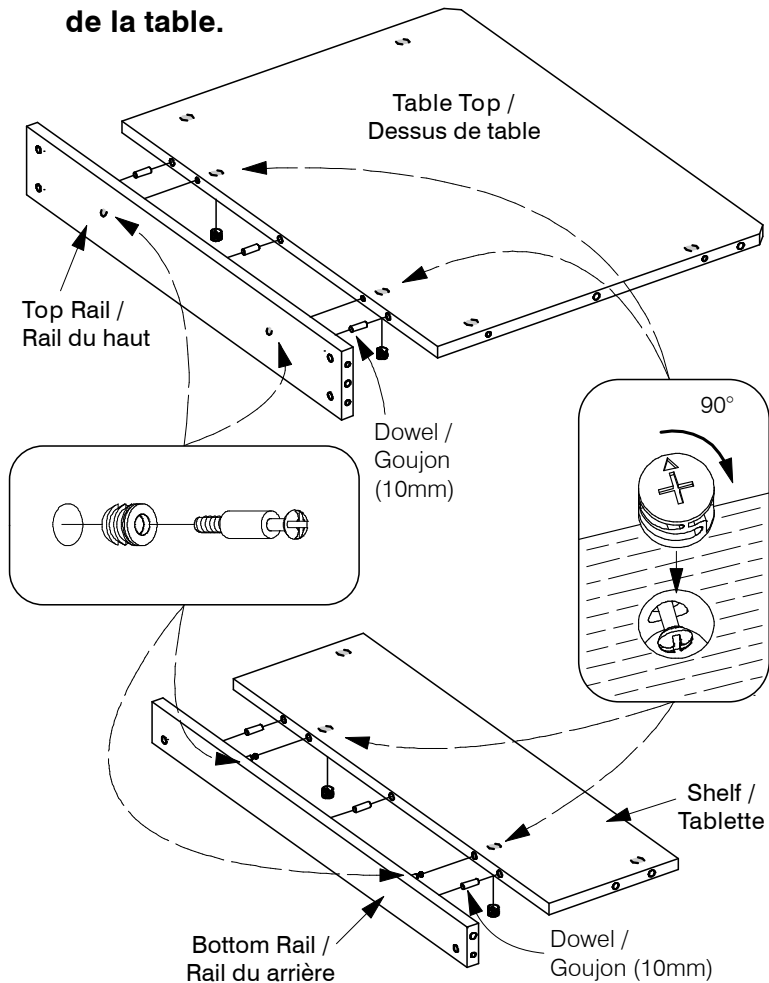

**6 Fit in the Drawer to the Desk / Poser insérer joindre le tiroir au bureau.**

**5 Assemble the Desk / Assembler le bureau.**

