

Assembly Instructions

BIFOLD FUTON FRAME SUNRISE ARM

See below for Preparation of arms for assembly.

BA-SUN-1016

1 One pair of Bifold Arms

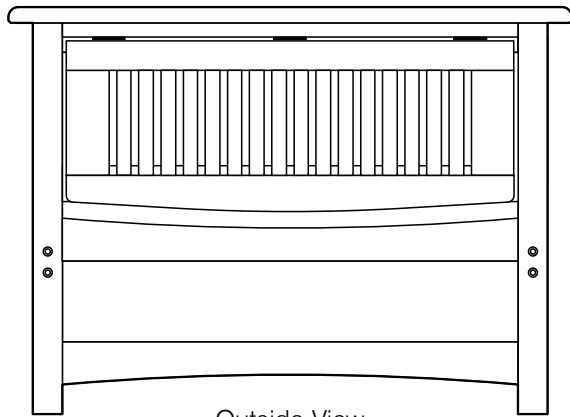

Outside View

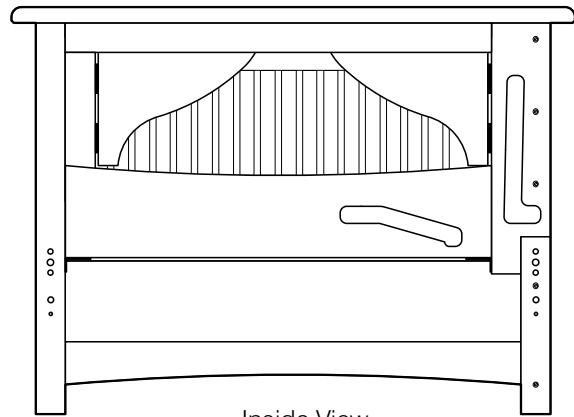

Inside View

2 Hardware in this box



100mm Bolts **x 8**
For the Front & Back Legs

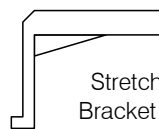

Stretcher Bracket **x 4**

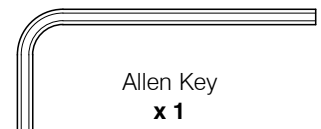

Allen Key **x 1**

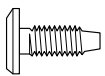

16mm Bolts **x 4**
For the Stretcher Brackets



Wood Button **x 8**



Barrel Nuts **x 8**



Wooden Dowel **x 4**

3 Fasten Stretcher Brackets to Arm

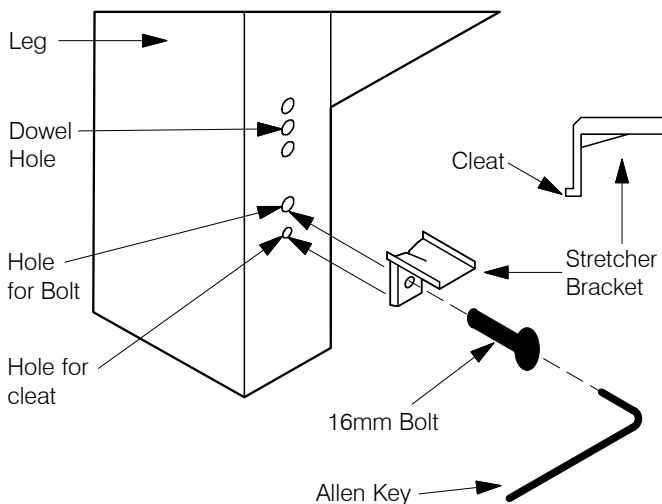

- Insert the Stretcher Bracket Cleat into the hole provided.
- IMPORTANT:** Don't fully tighten Bracket until Stretchers are all in place for easy alignment.
- Each arm requires two brackets, front and back.

4 Assemble the Bifold Body

BODY INSTRUCTIONS: Instructions for assembly of arms to the Wood Bifold Body are in the BODY box.

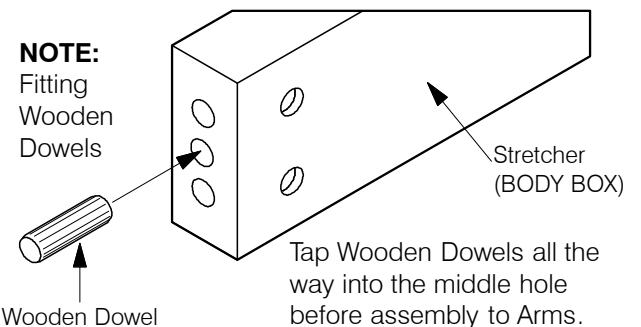

5 Fit Wood Button Into Arm Holes

AFTER TOTAL ASSEMBLY:

Push fit or lightly tap the wooden buttons into the bolt holes on the arms.

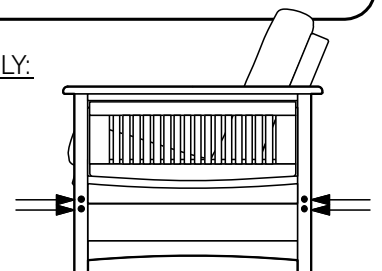

i Instructions for Bifold Body assembly, are packed in the Body box.

1 1 paire de bras

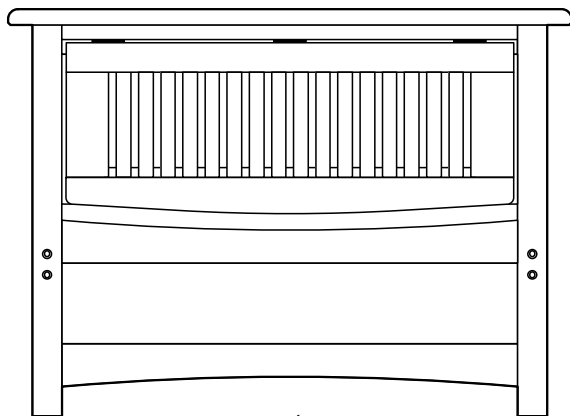

Vue extérieure

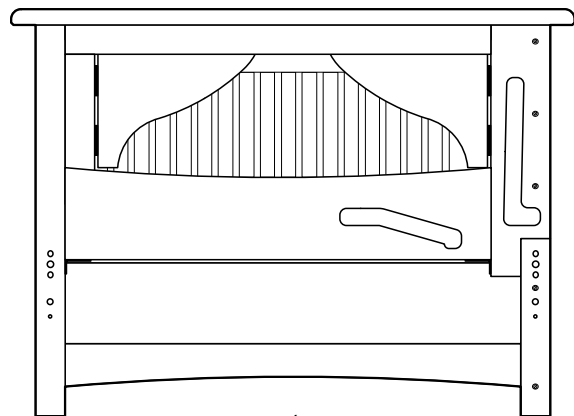

Vue intérieure

2 Quincaillerie dans cette boîte

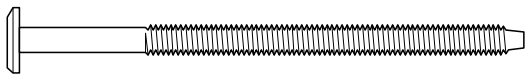

Vis (100mm) x 8
Pour les pattes avant et arrière

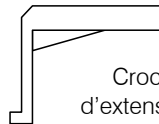

Crochets
d'extension x 4

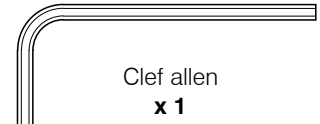

Clef allen
x 1

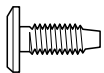

Vis (16mm) x 4
Pour les crochets d'extension



Boutons
de bois x 8



Écrous
x 8



Goujons
de bois x 4

3 Fixer les crochets d'extension au bras

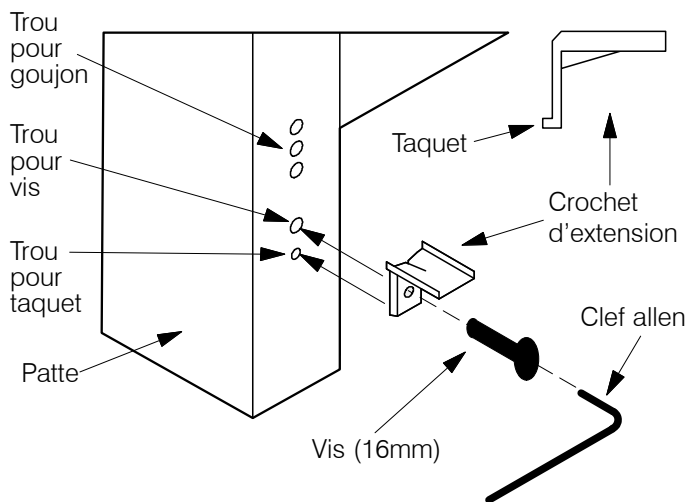

- Insérer le taquet du crochet d'extension dans le trou à cet effet.
- IMPORTANT:** Ne pas trop serrer le crochet tant que les rails d'écartement ne sont pas tous en place pour un alignement facile.
- Chaque bras requiert 2 crochets: avant et arrière

4 Assembler le châssis pliant en bois

INSTRUCTIONS POUR LE CHÂSSIS:

Les instructions pour l'assemblage des bras au châssis pliant en bois sont dans la boîte du châssis.

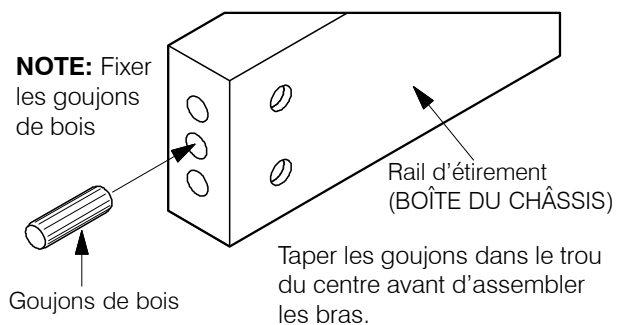

5 Mettre les boutons en bois dans les trous des bras.

APRÈS L'ASSEMBLAGE TERMINÉ:

Pousser doucement pour ajuster les boutons de bois dans les trous de vis des bras

