

1A Parts in this box.

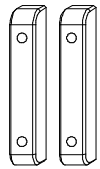

Wood Cap x 2

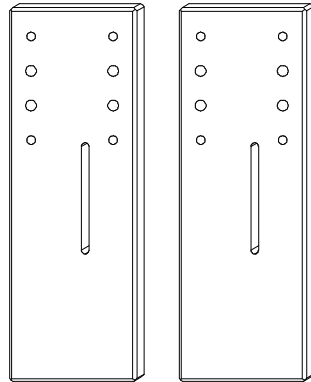

Headboard Adapter x 2

1B Hardware in this box.

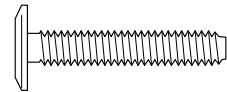

M8 x 40mm JCBB Bolts
x 4

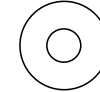

Washer
x 4



Spring Washer
x 4

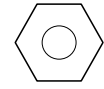

M8 Nut
x 4



Wooden Dowel
x 4



Allen Key
x 1

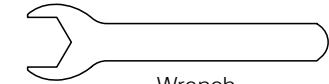

Wrench
x 1

1C Assembly of the Headboard Adapter to the Bed Brackets.

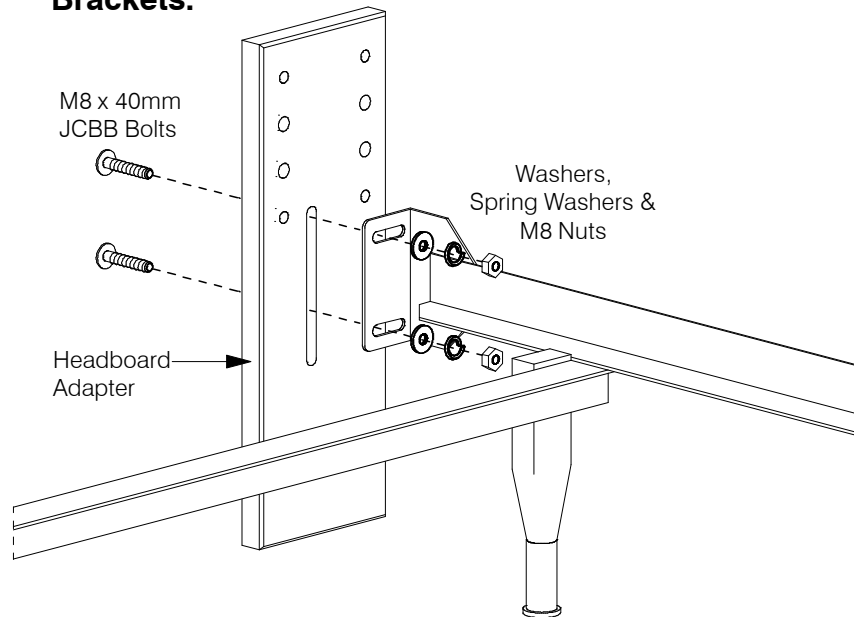

1D Assembly of the Headboard Adapter to the Headboard.

