

# Assembly Instructions

# BIFOLD FUTON FRAME EUREKA ARM

See below for Preparation of arms for assembly.

BA-EUR-1016

## 1 One pair of Bifold Arms

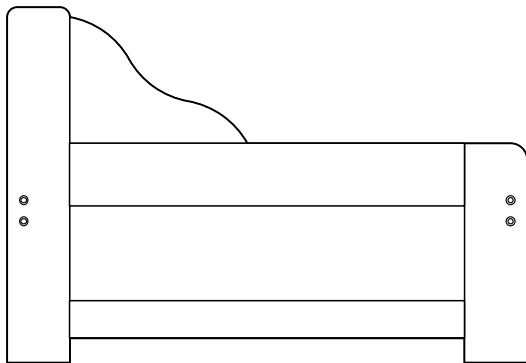

Outside View

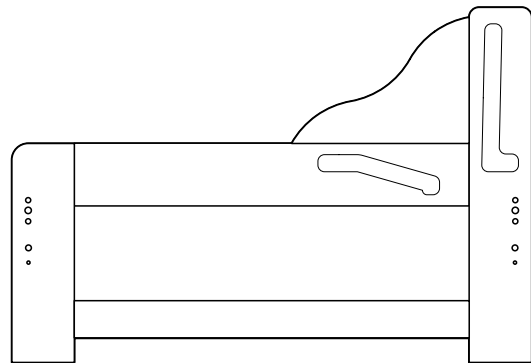

Inside View

## 2 Hardware in this box

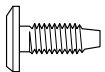

16mm Bolts **x 4**  
For the Stretcher Brackets

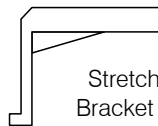

Stretcher Bracket **x 4**

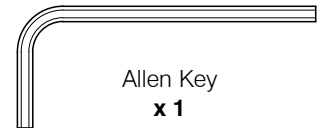

Allen Key **x 1**



60mm Bolts **x 8**  
For the Front & Back Legs



Wood Button **x 8**



Barrel Nuts **x 8**



Wooden Dowel **x 4**

## 3 Fasten Stretcher Brackets to Arm

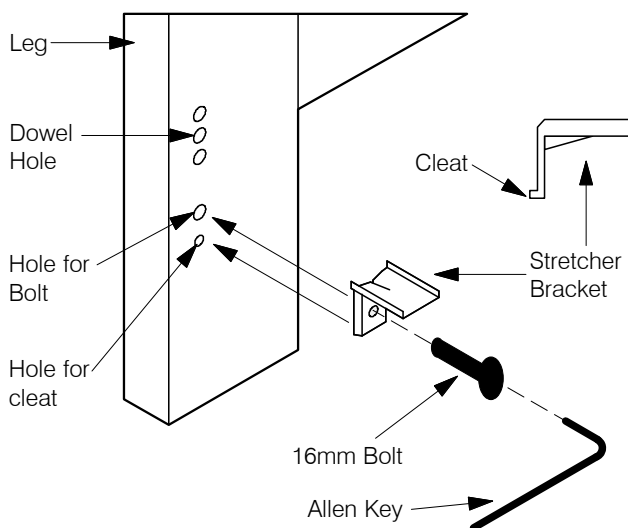

- Insert the Stretcher Bracket Cleat into the hole provided.
- IMPORTANT:** Don't fully tighten Bracket until Stretchers are all in place for easy alignment.
- Each arm requires two brackets, front and back.

## 4 Assemble the Bifold Body

**BODY INSTRUCTIONS:** Instructions for assembly of arms to the Wood Bifold Body are in the BODY box.

**NOTE:**  
Fitting  
Wooden  
Dowels

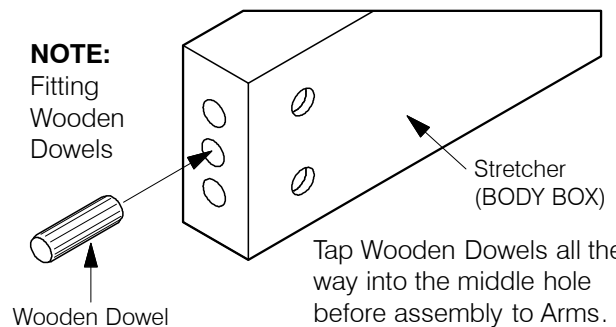

Tap Wooden Dowels all the way into the middle hole before assembly to Arms.

## 5 Fit Wood Button Into Arm Holes

**AFTER TOTAL ASSEMBLY:**

Push fit or lightly tap the wooden buttons into the bolt holes on the arms.

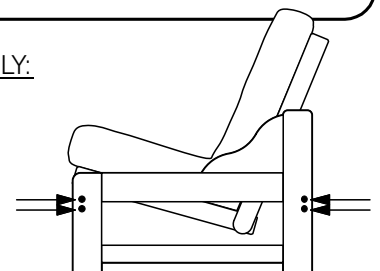

**i** Instructions for Bifold Body assembly, are packed in the Body box.

**1** 1 paire de bras

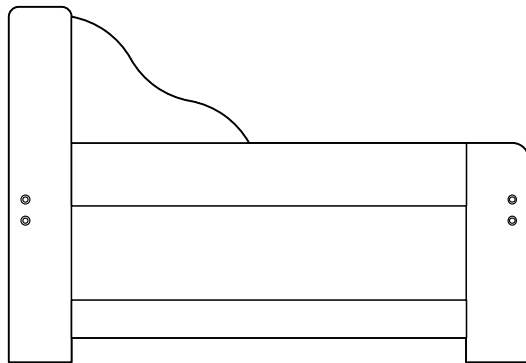

Vue extérieure

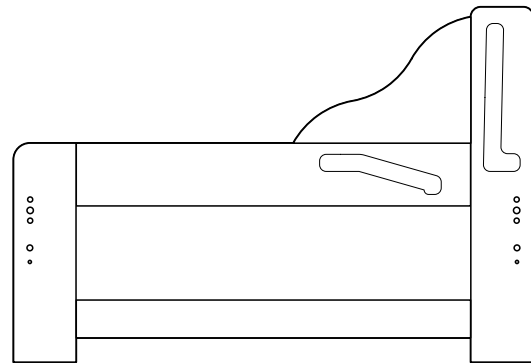

Vue intérieure

**2** Quincaillerie dans cette boîte

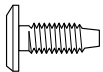

Vis (16mm) x 4  
Pour les crochets d'extension

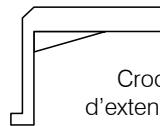

Crochets  
d'extension x 4

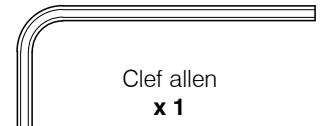

Clef allen  
x 1



Vis (60mm) x 8  
Pour les pattes avant et arrière



Boutons  
de bois x 8



Écrous  
x 8



Goujons  
de bois x 4

**3** Fixer les crochets d'extension au bras

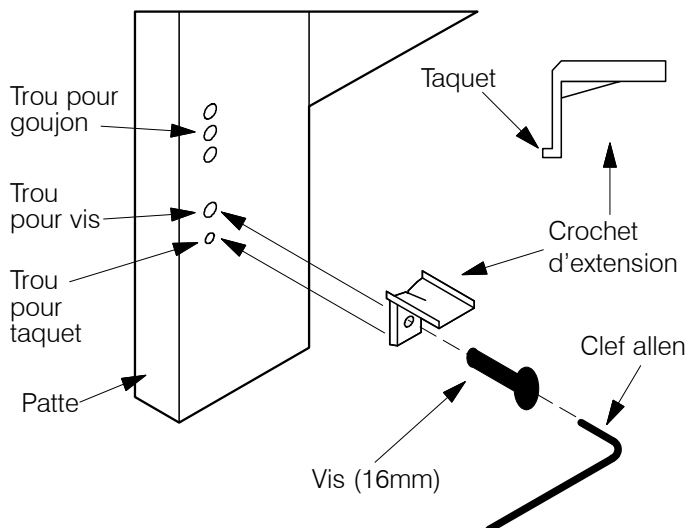

- Insérer le taquet du crochet d'extension dans le trou à cet effet.
- IMPORTANT:** Ne pas trop serrer le crochet tant que les rails d'étirement ne sont pas tous en place pour un alignement facile.
- Chaque bras requiert 2 crochets: avant et arrière

**4** Assembler le châssis pliant en bois

INSTRUCTIONS POUR LE CHÂSSIS:

Les instructions pour l'assemblage des bras au châssis pliant en bois sont dans la boîte du châssis.

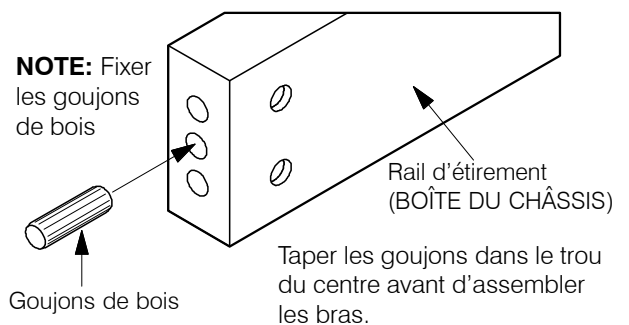

**5** Mettre les boutons en bois dans les trous des bras.

APRÈS L'ASSEMBLAGE TERMINÉ:

Pousser doucement pour ajuster les boutons de bois dans les trous de vis des bras

