

1A Parts in this Box:

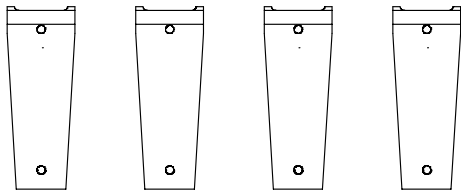

Small Legs **x 4**



Wooden Feet **x 4**

1B Slats are Packed Separately in Box 4.

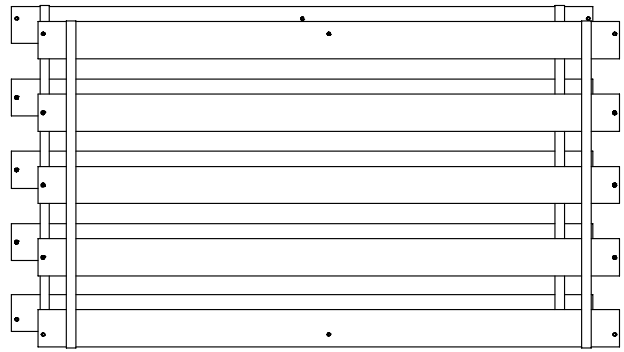

Set of Slats **x 2**

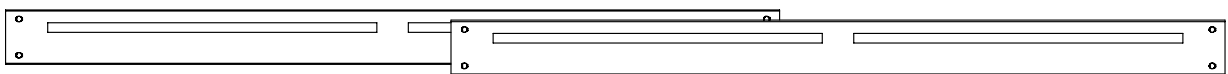

Stretchers **x 2**



Center Rail **x 1**

1C Hardware in this box.

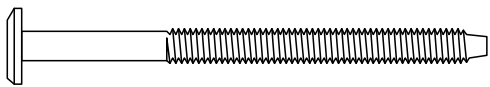

80mm Bolts **x 4**

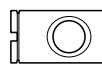

Barrel Nuts **x 8**

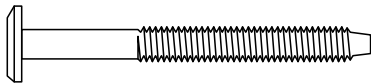

60mm Bolts **x 4**

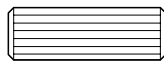

Wooden Dowels **x 8**



ThumNut™ **x 8**
Patent No.: US 6,457,923

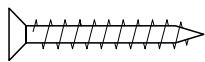

30mm Wood Screws **x 12**

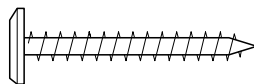

40mm Threaded Wood Bolts **x 10**



Long Allen Key **x 1**

1D Fit Wood Dowels to the Stretchers:

Tap the Wooden Dowels all the way into the Middle holes at the ends of the Stretchers.

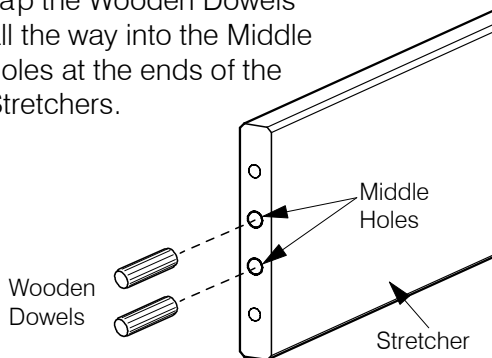

1E Fit the Small Legs to the Center Rail.

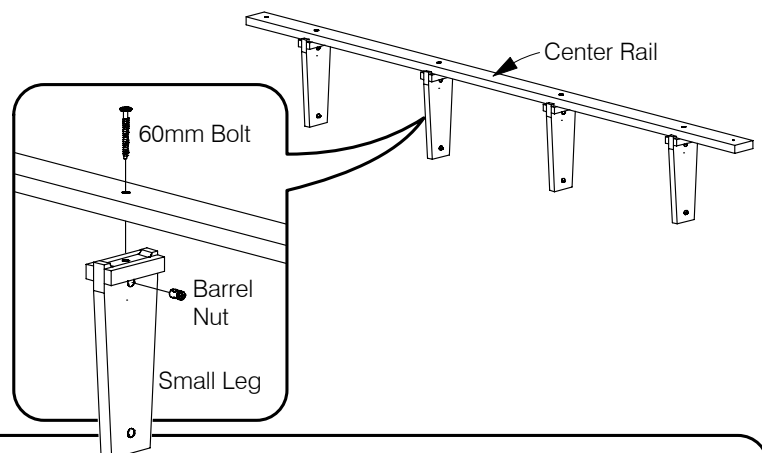

2A Attach the Stretchers to the Headboard and Footboard.

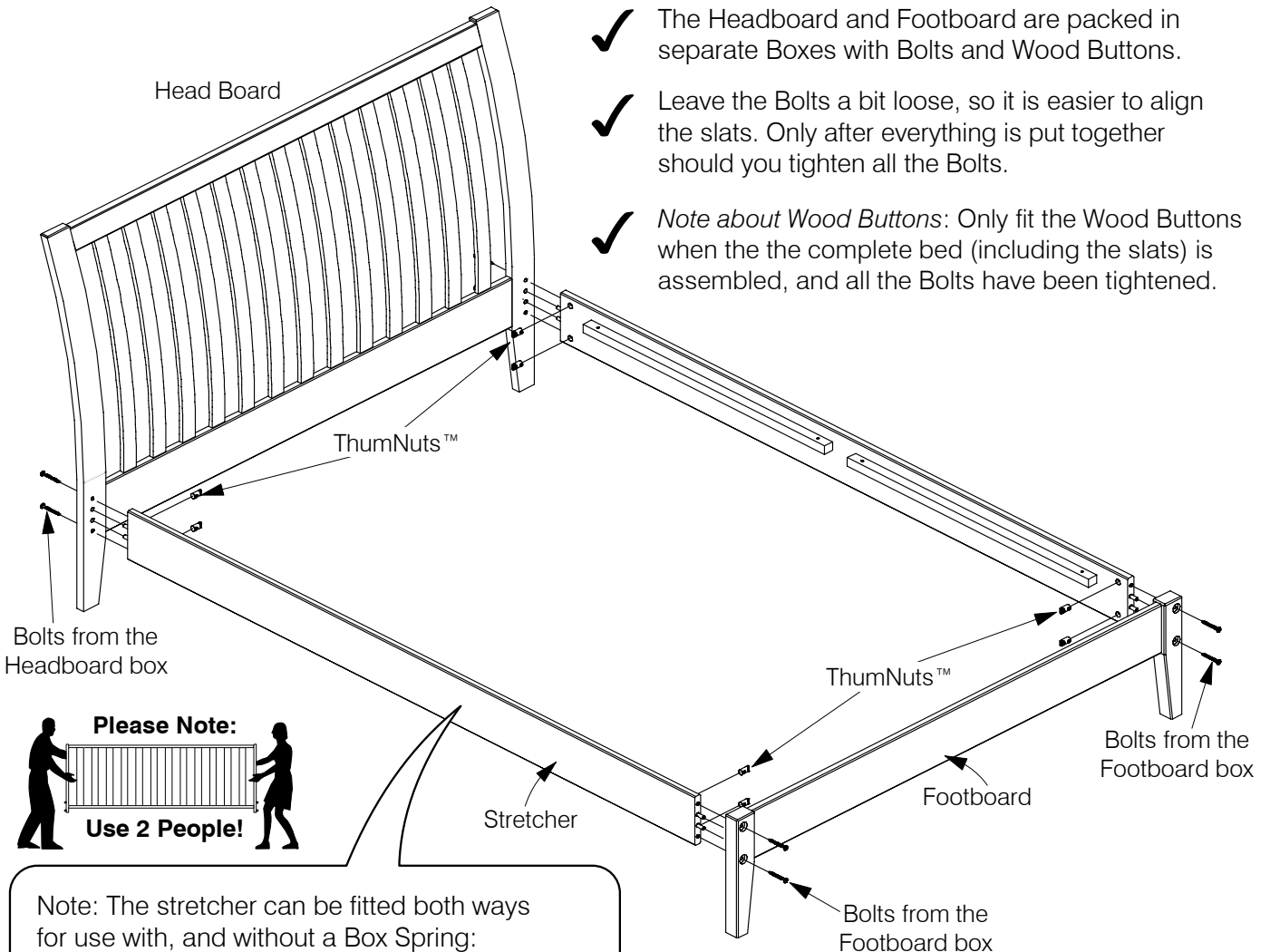

- ✓ The Headboard and Footboard are packed in separate Boxes with Bolts and Wood Buttons.
- ✓ Leave the Bolts a bit loose, so it is easier to align the slats. Only after everything is put together should you tighten all the Bolts.
- ✓ *Note about Wood Buttons:* Only fit the Wood Buttons when the the complete bed (including the slats) is assembled, and all the Bolts have been tightened.

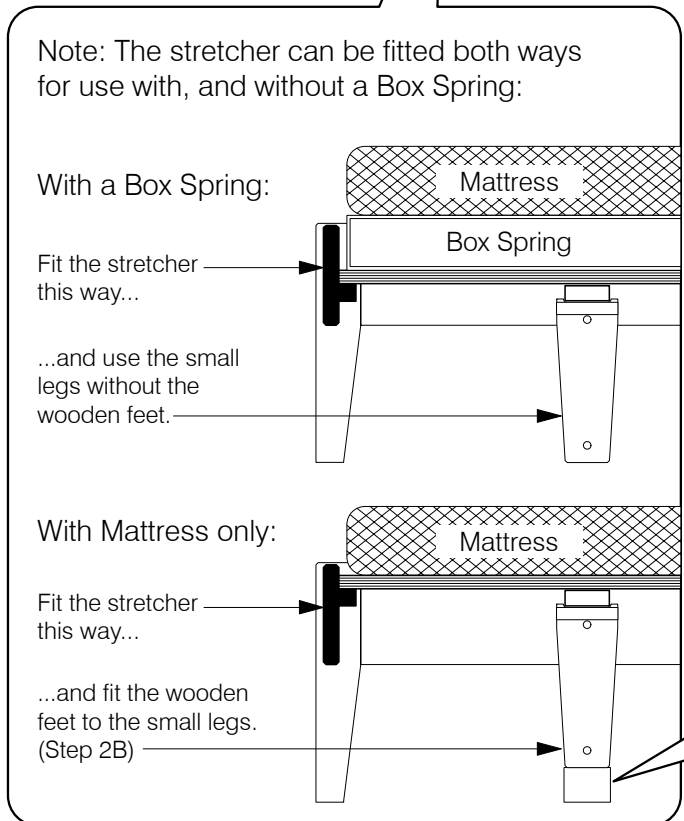
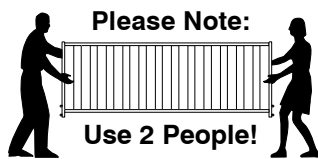

2B For Mattress Only: Fit the Wooden Feet to the Small Legs.

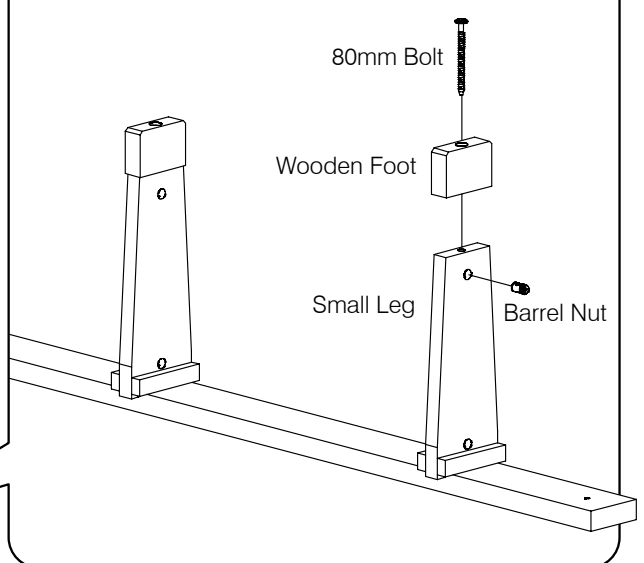

4A Fit the other Set of Slats between the Stretchers.

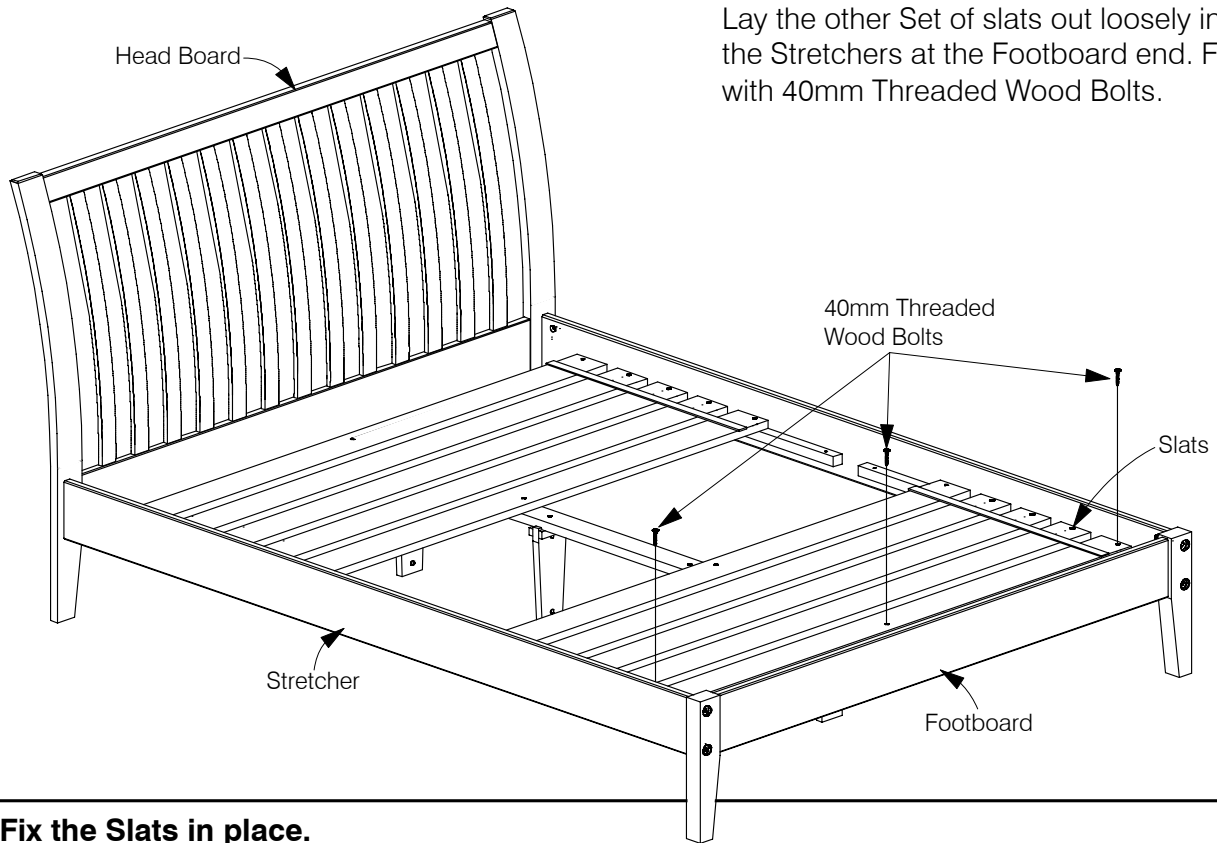

Lay the other Set of slats out loosely inside the Stretchers at the Footboard end. Fix with 40mm Threaded Wood Bolts.

4B Fix the Slats in place.

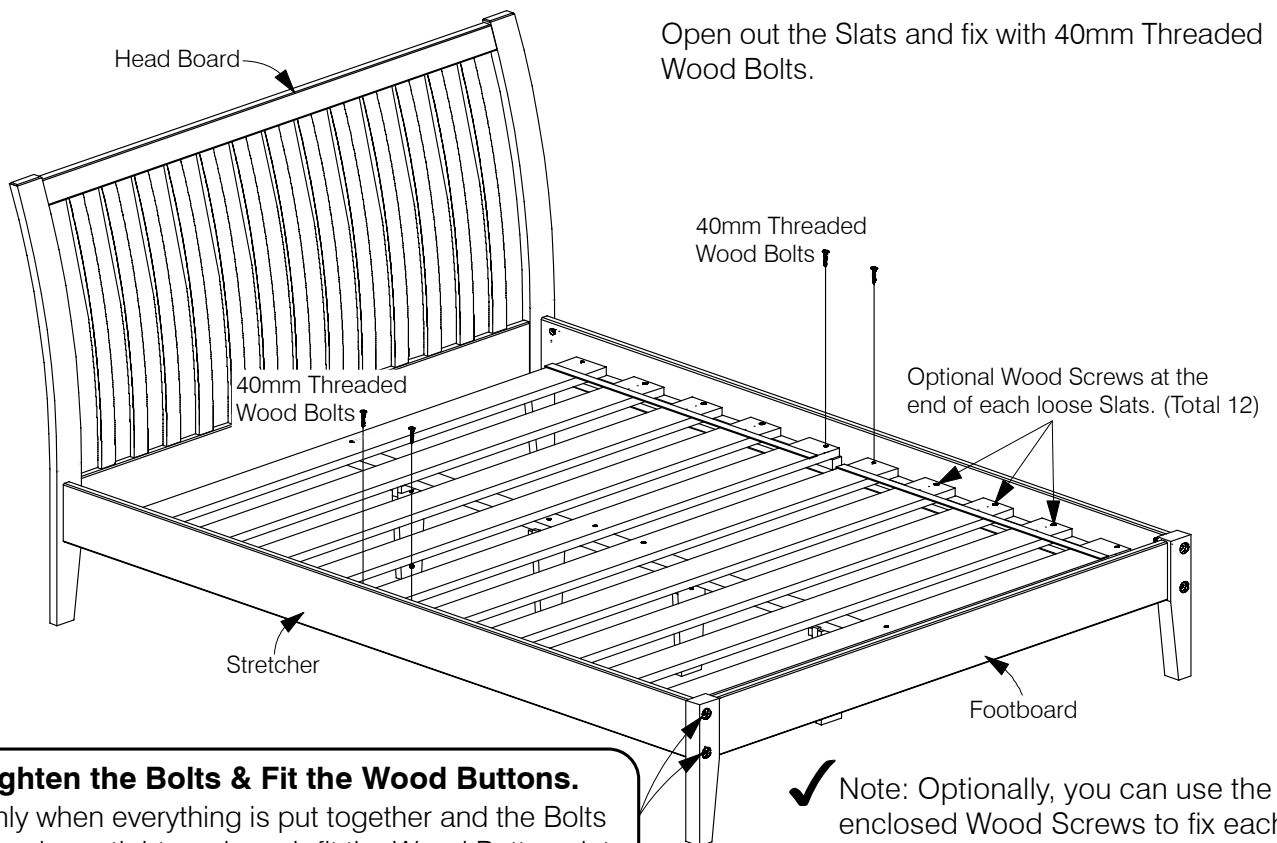

Open out the Slats and fix with 40mm Threaded Wood Bolts.

4C Tighten the Bolts & Fit the Wood Buttons.

Only when everything is put together and the Bolts have been tightened, push fit the Wood Buttons into the Bolt holes.

✓ Note: Optionally, you can use the enclosed Wood Screws to fix each slat in place. An electric screwdriver will make this much easier.