

Assembly Instructions

Cinnamon Twin Bunk Bed

N&D 0307

SAFETY WARNING

1. Follow the information on the warnings appearing on the upper bunk end structure and on the carton. Do not remove warning label from bed.
2. Always use the recommended size mattress or mattress support, or both, to help prevent the likelihood of entrapment or falls.
3. Surface of mattress must be at least 5 in. (127 mm) below the upper edge of guardrails.
4. Do not allow children under 6 years of age to use the upper bunk.
5. Periodically check and ensure that the guardrail, ladder, and other components are in their proper position, free from damage, and that all connectors are tight.
6. Do not allow horseplay on or under the bed and prohibit jumping on the bed.
7. Always use the ladder for entering and leaving the upper bunk.
8. Do not use substitute parts. Contact the manufacturer or dealer for replacement parts.
9. Use of a night light may provide added safety precaution for a child using the upper bunk.
10. Always use guardrails on both long sides of the upper bunk. If the bunk bed will be placed next to the wall, the guardrail that runs the full length of the bed should be placed against the wall to prevent entrapment between the bed and wall.
11. The use of water or sleep flotation mattresses is prohibited.
12. STRANGULATION HAZARD—Never attach or hang items to any part of the bunk bed that are not designed for use with the bed; for example, but not limited to, hooks, belts and jump ropes.
13. Keep these instructions for future reference.

SIZE OF MATTRESS AND FOUNDATION:

Use only mattress, which is 37 1/2" - 38 1/2" width and 74"-75" long on upper bunk (twin size.) Ensure that the thickness of the mattress does not exceed 6" and that the mattress surface is at least 5" (127mm) below upper edge of guardrails.

Replacement Parts:

Replacement parts, including additional guardrails may be obtained from any Night & Day Furniture Dealer.

Certified:

This bunk bed conforms to all applicable consumer product safety standards 16 CFR PARTS 1213, 1500, 1513 and ASTM F-1427



NIGHT
FURNITURE
DAY™

Assembly Instructions

Cinnamon Twin Bunk Bed

N&D 0307

1A Parts in Box 1

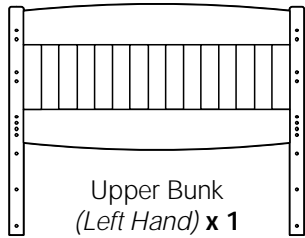

Upper Bunk
(Left Hand) x 1

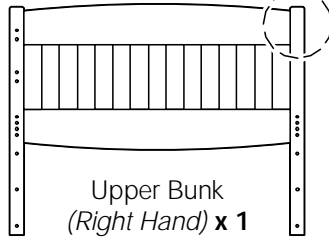

Upper Bunk
(Right Hand) x 1

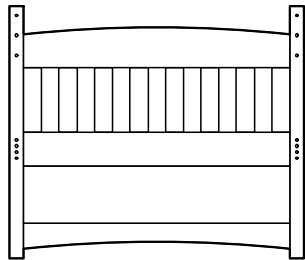

Lower Bunk x 1

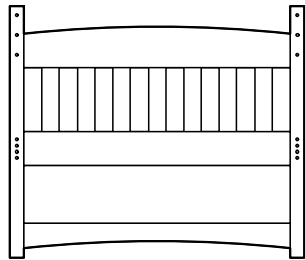

Lower Bunk x 1

Parts in Box 2

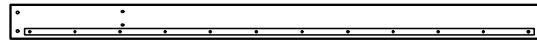

Upper Stretcher (with extra holes) x 1

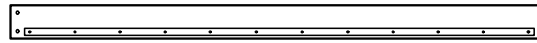

Upper Stretcher x 1

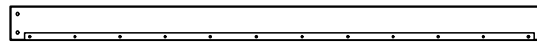
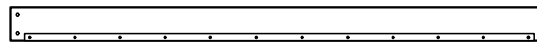

Bottom Stretcher x 2

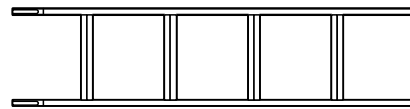

Ladder x 1

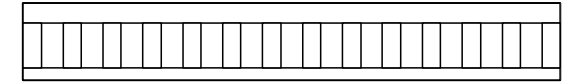

Rear Guard Rail x 1

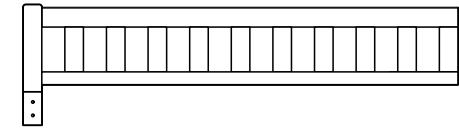

Front Guard Rail x 1



Brackets x 4

Parts in Box 3

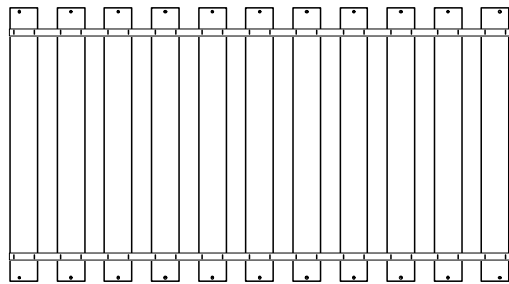

Set of Slats x 2

1B Hardware in this Box.



Wood Dowels x 25



Barrel Nuts x 19

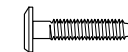

30mm Bolts x 2



40mm Threaded
Wood Bolts x 8

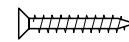

30mm Wood
Screws x 36



16mm Wood
Screws x 2



100mm Bolts x 19

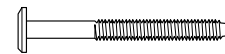

60mm Bolts x 16

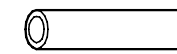

Metal Tubes x 4

Tools required for assembly:

- Allen Key (supplied)
- Phillips Screwdriver (not supplied)

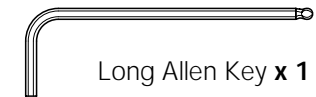

Long Allen Key x 1

Assembly Instructions

Cinnamon Twin Bunk Bed

N&D 0906

2A Fit Wood Dowels to the Stretchers.

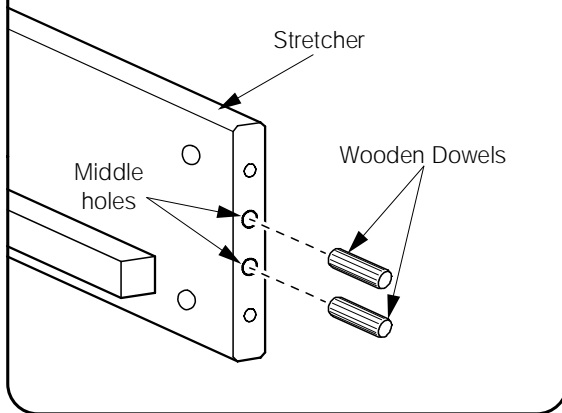

2B Attach Stretchers to Lower Frame.

Using 100mm Bolts and Barrel Nuts provided with the Lower Frame, attach the Lower Frame to the Stretchers as shown.

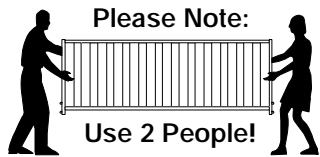
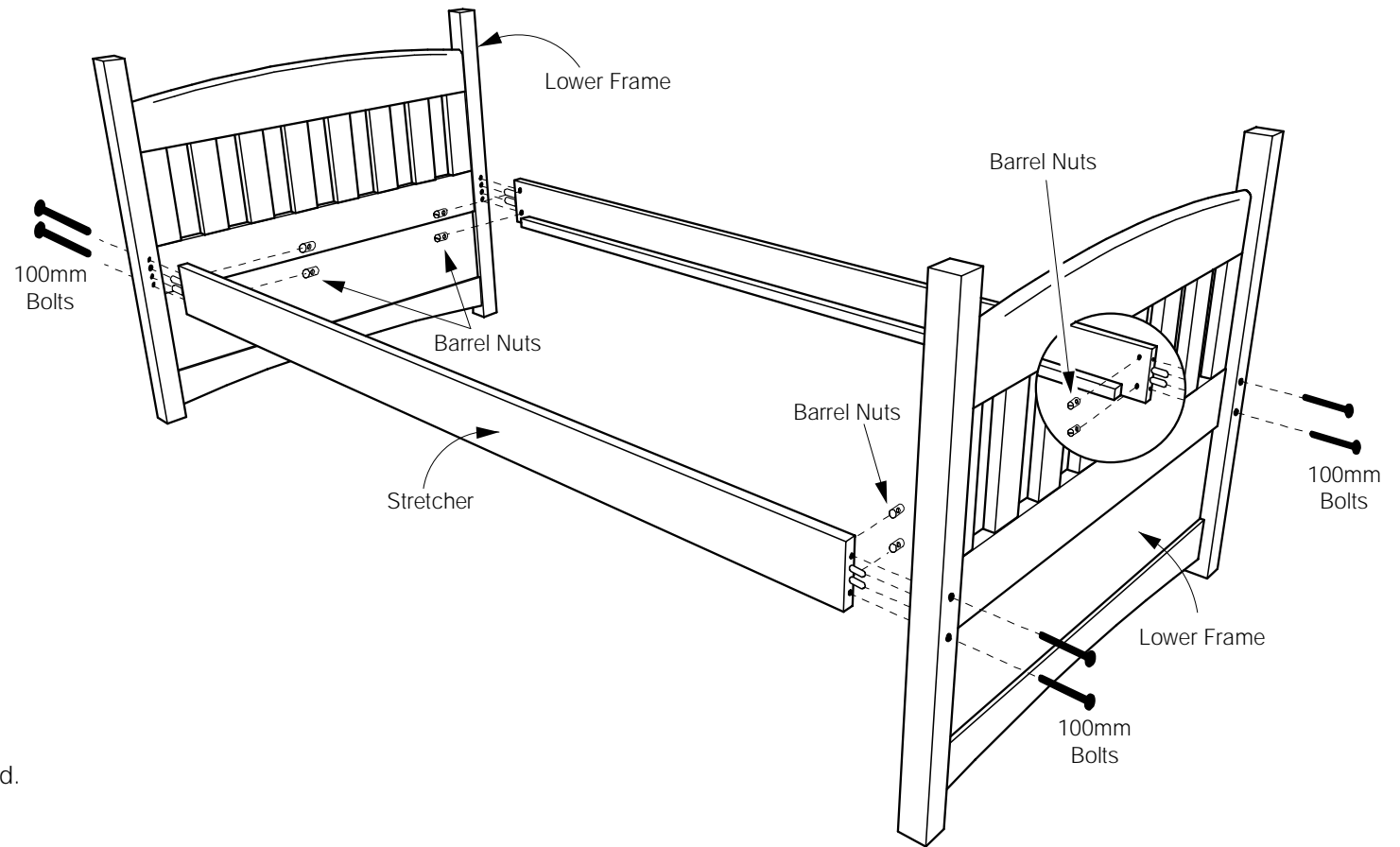

Bolt and Barrel Nut Assembly.

- ✓ Do not force the Bolt as you may strip the thread. Be sure the thread is properly started.
- ✓ Be sure the holes are free of wood chips and saw dust.

Assembly Instructions

Cinnamon Twin Bunk Bed

N&D 0307

3A Fit Slats between the Stretchers.

Lay the Slats inside the Stretchers as shown below, and Bolts in place with 40mm Threaded Wood Bolts (total 4 Bolts)

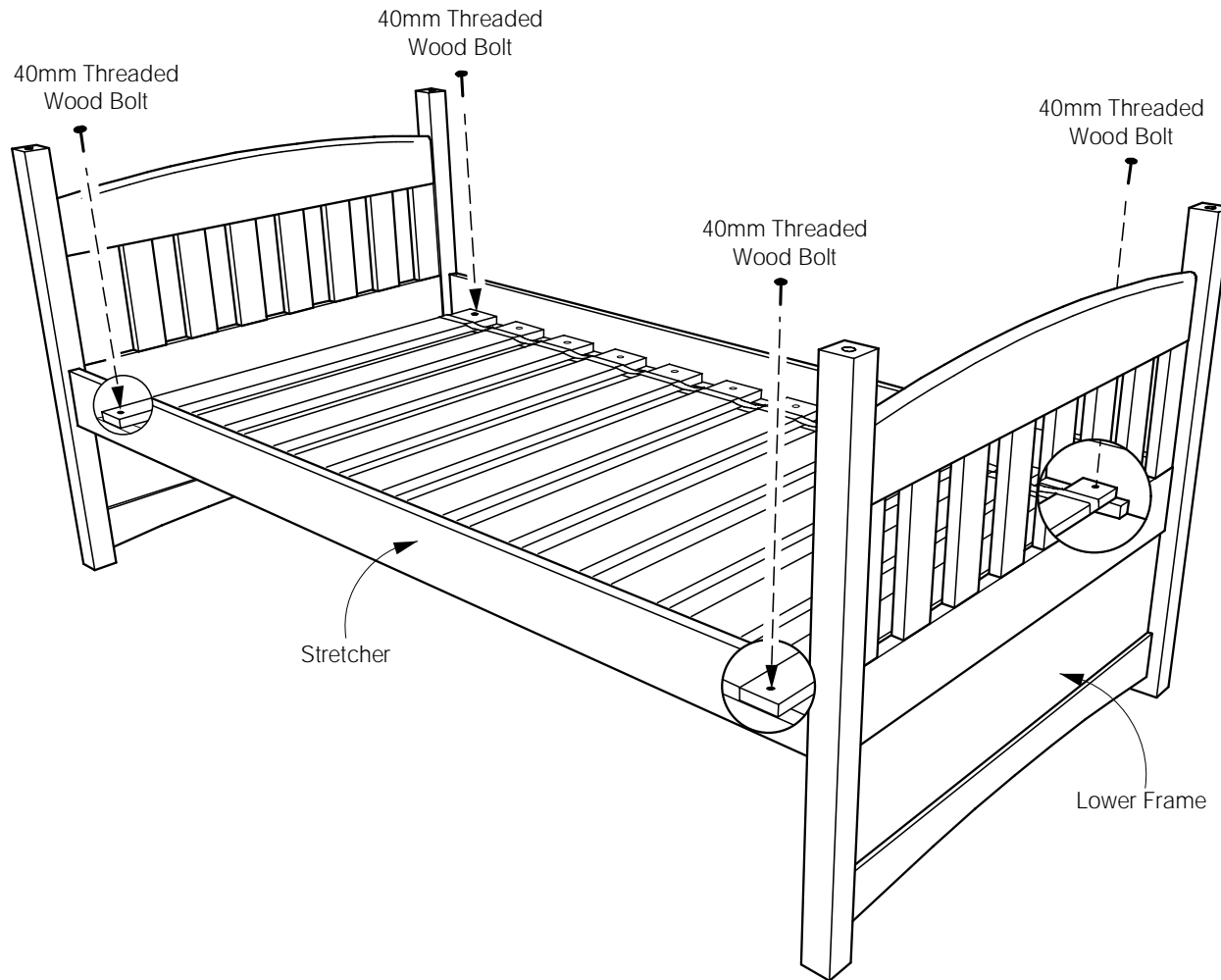

3B Fix the Remaining Slats with screws.

Use the 30mm Wood Screws to fix the remaining slats to the Stretchers (total 18 screws.) An electric screwdriver will make this much easier.

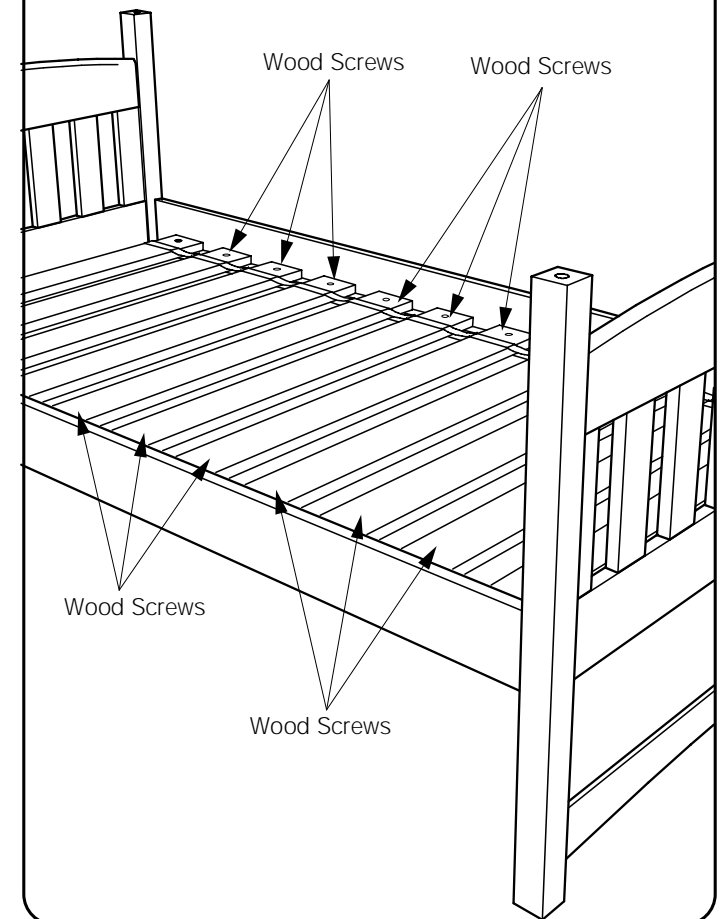

Assembly Instructions

Cinnamon Twin Bunk Bed

N&D 0906

4A Attach the Stretchers and Rear Guard Rail to the Upper Bunk.

Tap Wooden Dowels into the ends of the Stretchers and Rear Guard Rail. Using 100mm Bolts and Barrel Nuts, attach these to the Upper Bunk, carefully noting Left and Right hand sides.

Bolt and Barrel Nut Assembly.

- ✓ Do not force the Bolt as you may strip the thread. Be sure the thread is properly started.
- ✓ Be sure the holes are free of wood chips and saw dust.

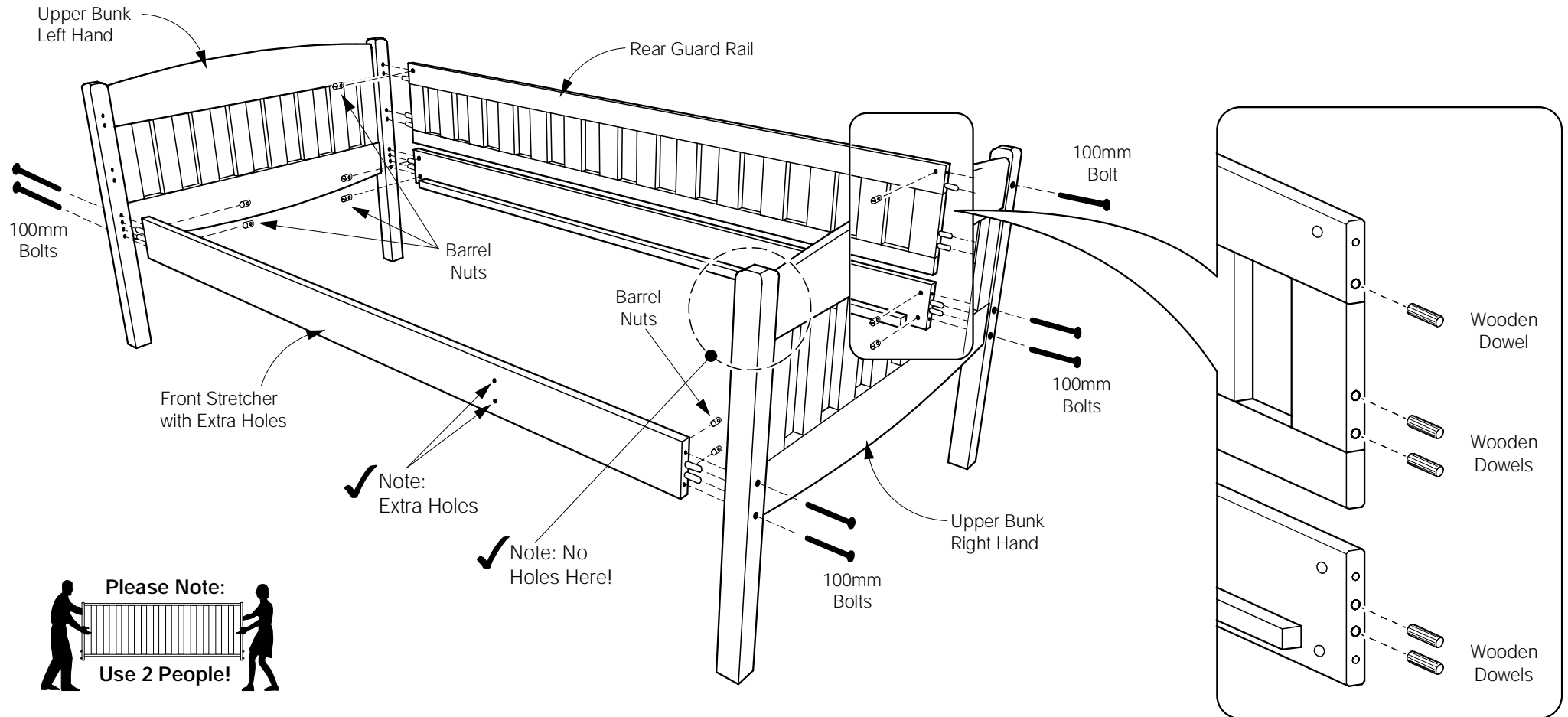

Assembly Instructions

Cinnamon Twin Bunk Bed

N&D 0307

5A Attach Front Guard Rail to the Upper Bunk.

Tap Wooden Dowels into the ends of the Front Guard Rail. use the 100mm Bolts and Barrel Nuts fix it in place. The Front Guard Rail attaches to the Stretcher using the 30mm Bolts.

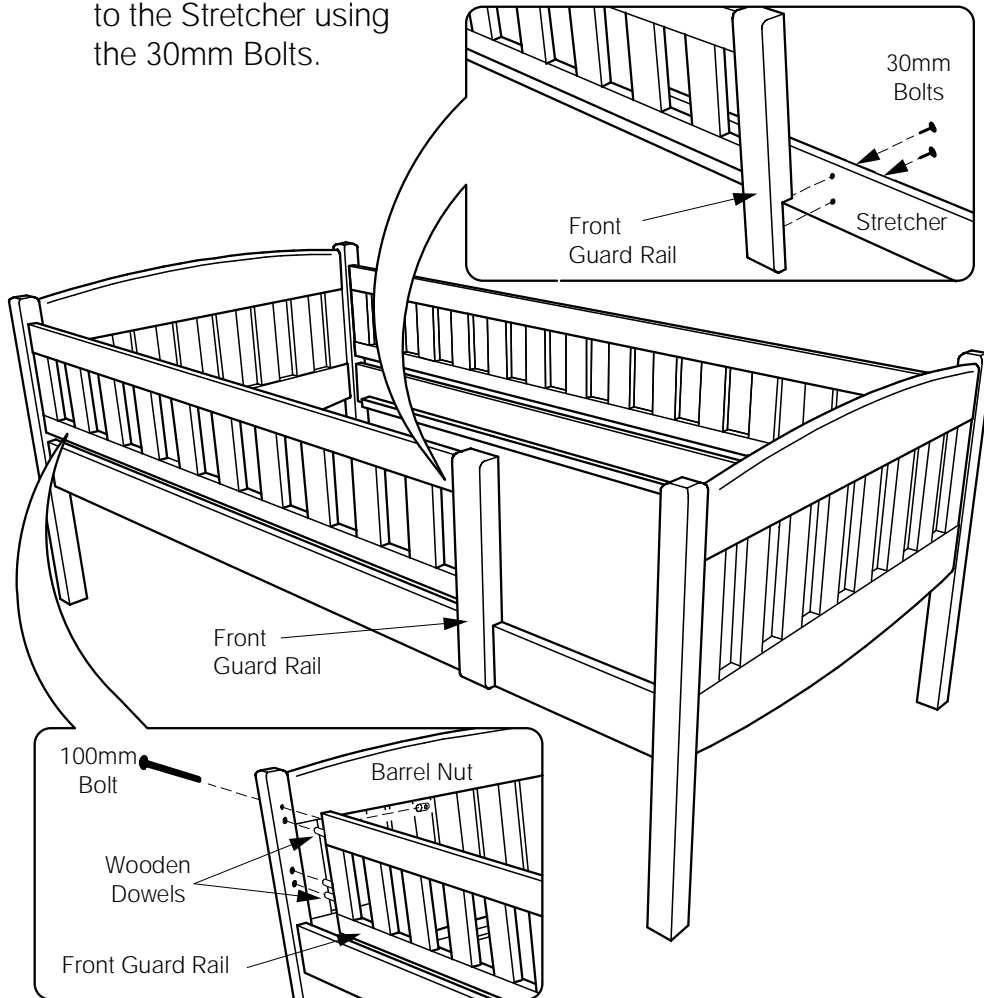

5B Bolt the Slats to the Stretchers.

Lay the Slats inside the Stretchers as shown below, and Bolt in place with the 40mm Threaded Wood Bolts (total 4 Bolts.)

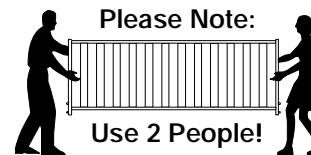
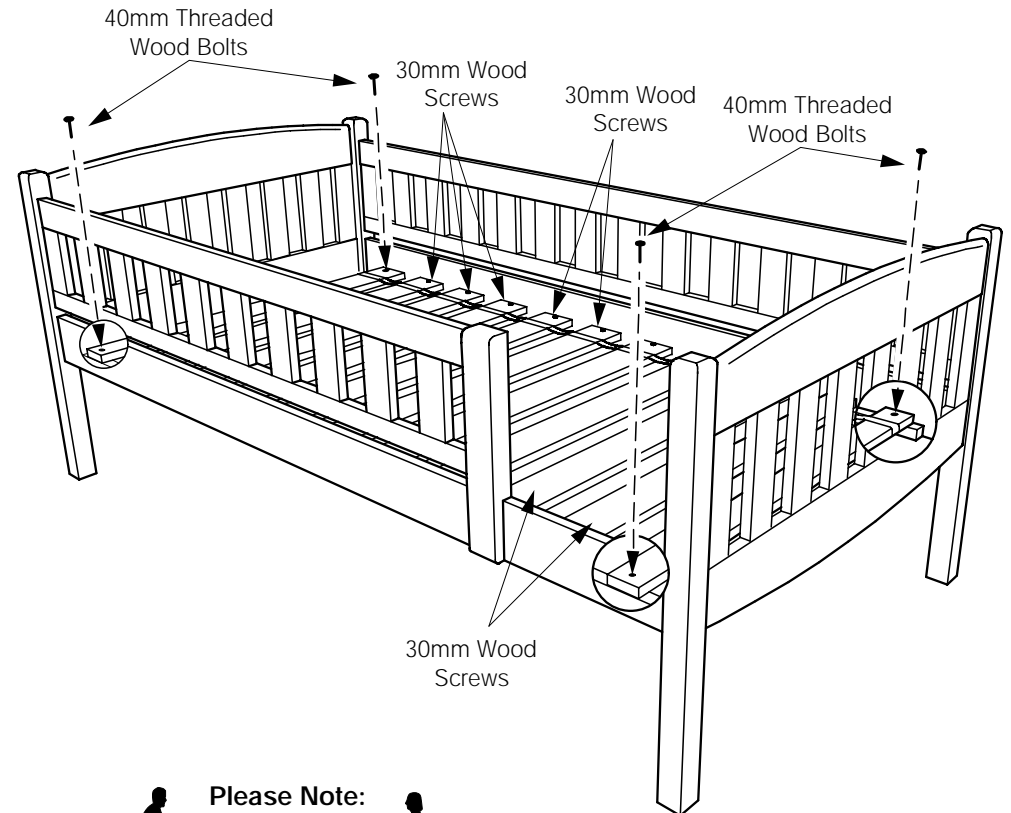

Assembly Instructions

Cinnamon Twin Bunk Bed

N&D 0906

6A Fit the Upper Bunk onto the Lower Bunk.

Fit the Metal Tubes into the tops of the legs. Carefully Lift the Top Bunk onto the Lower Bunk.

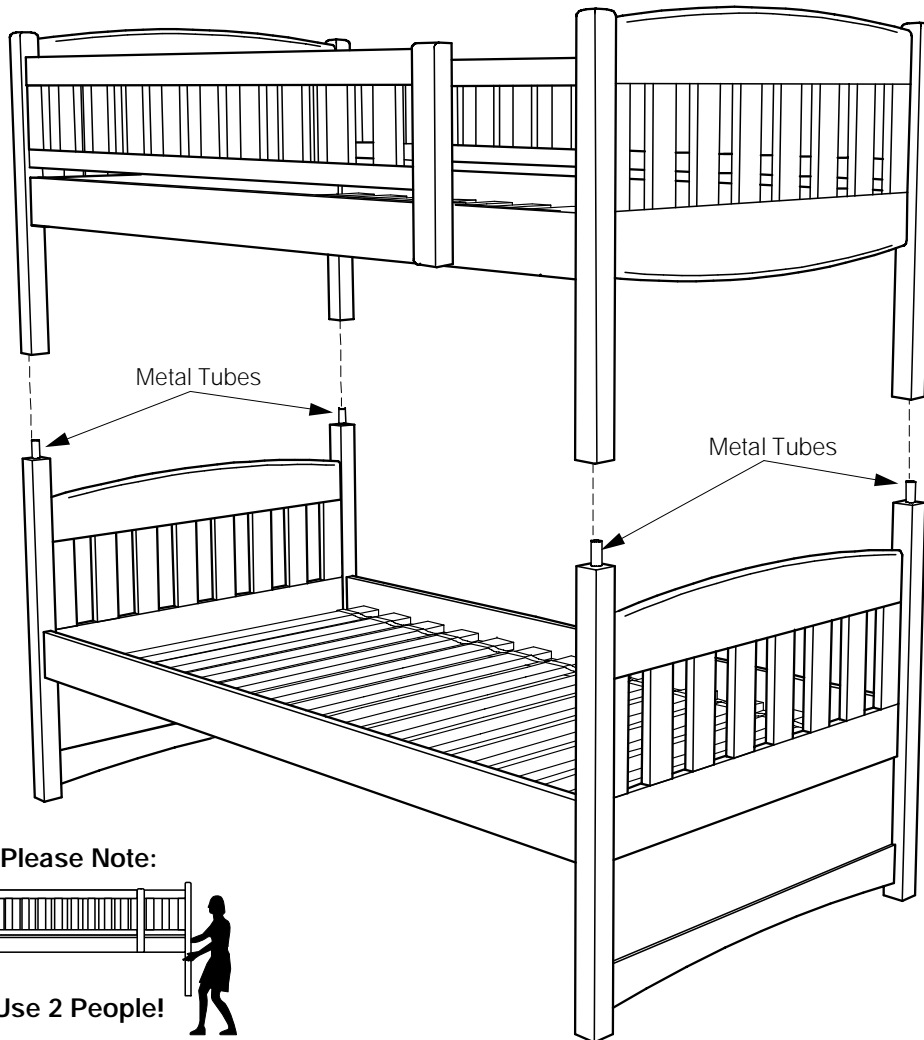

6B Fit the Brackets to the Legs.

Use the 60mm Bolts to fix the Brackets to the Legs.

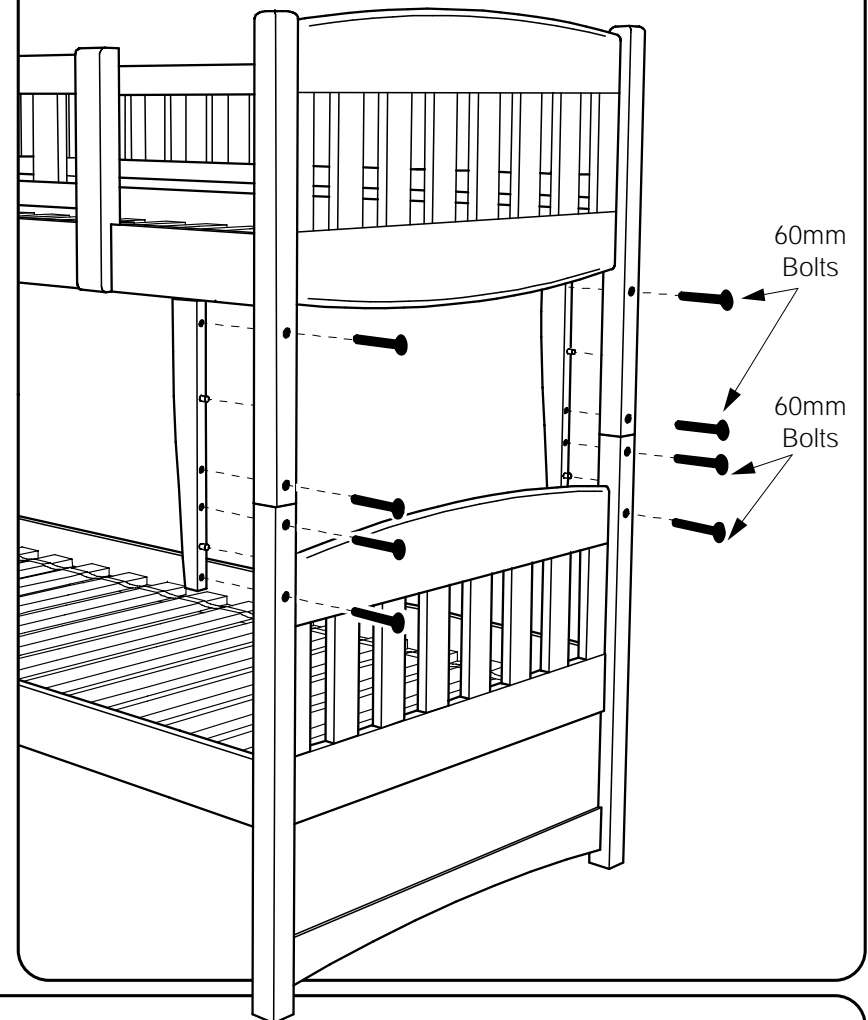

Assembly Instructions
Cinnamon Twin Bunk Bed

N&D 0906

7A Attach the Ladder to the Upper Stretcher.

Finally, hook the Ladder onto the Upper Stretcher. Use the 16mm Wood Screws to fix the Ladder in place.

- Please take note of the warnings shown on page one of these instructions, printed on the carton box and on stickers on the Bunk bed.

