

⚠ SAFETY WARNING

1. Follow the information on the warnings appearing on the upper bunk end structure and on the carton. Do not remove warning label from bed.
2. Always use the recommended size mattress or mattress support, or both, to help prevent the likelihood of entrapment or falls.
3. Surface of mattress must be at least 5 in. (127 mm) below the upper edge of guardrails.
4. Do not allow children under 6 years of age to use the upper bunk.
5. Periodically check and ensure that the guardrail, ladder, and other components are in their proper position, free from damage, and that all connectors are tight.
6. Do not allow horseplay on or under the bed and prohibit jumping on the bed.
7. Always use the ladder for entering and leaving the upper bunk.
8. Do not use substitute parts. Contact the manufacturer or dealer for replacement parts.
9. Use of a night light may provide added safety precaution for a child using the upper bunk.
10. Always use guardrails on both long sides of the upper bunk. If the bunk bed will be placed next to the wall, the guardrail that runs the full length of the bed should be placed against the wall to prevent entrapment between the bed and wall.
11. The use of water or sleep flotation mattresses is prohibited.
12. STRANGULATION HAZARD—Never attach or hang items to any part of the bunk bed that are not designed for use with the bed; for example, but not limited to, hooks, belts and jump ropes.
13. Keep these instructions for future reference.

SIZE OF MATTRESS AND FOUNDATION:

Use only mattress, which is 37 1/2" - 38 1/2" width and 74"-75" long on upper bunk (twin size.) Ensure that the thickness of the mattress does not exceed 6" and that the mattress surface is at least 5" (127mm) below upper edge of guardrails.

Replacement Parts:

Replacement parts, including additional guardrails may be obtained from any [Night & Day Furniture Dealer](#).

Certified:

This bunk bed conforms to all applicable consumer product safety standards 16 CFR PARTS 1213, 1500, 1513 and ASTM F-1427



1A Parts List: Box 1 - Head/Footboards:

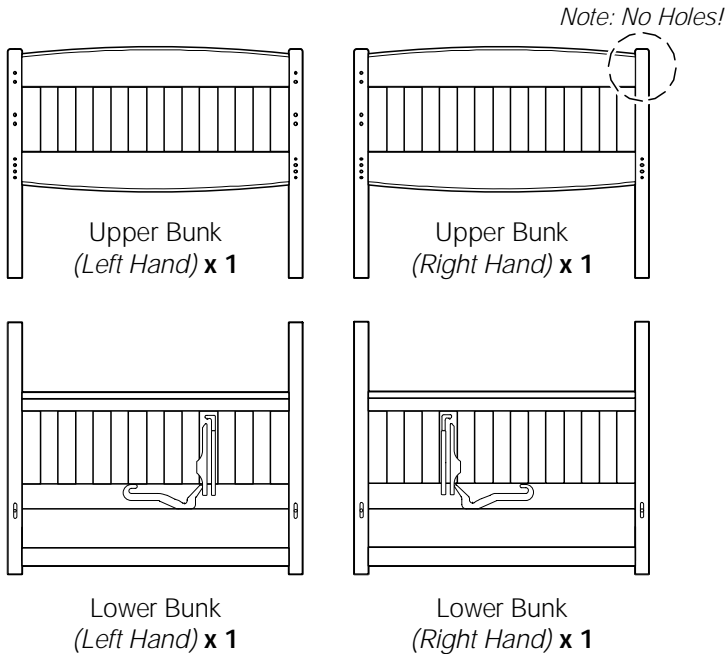

Box 2 - Futon Decks and Stretchers:

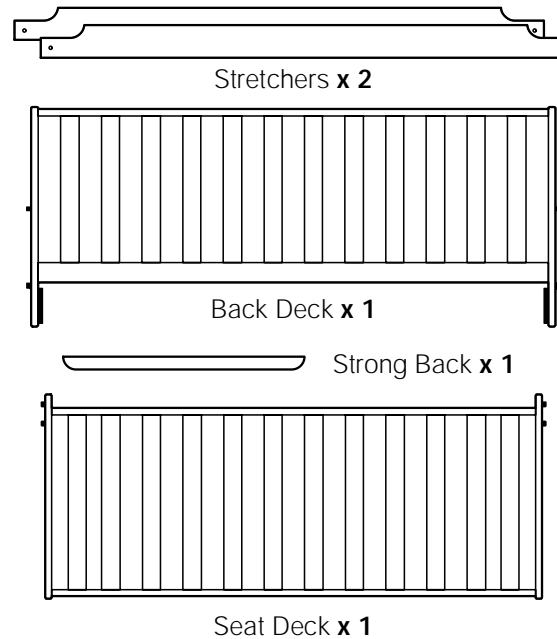

Box 3 - Guard Rails and Ladder:

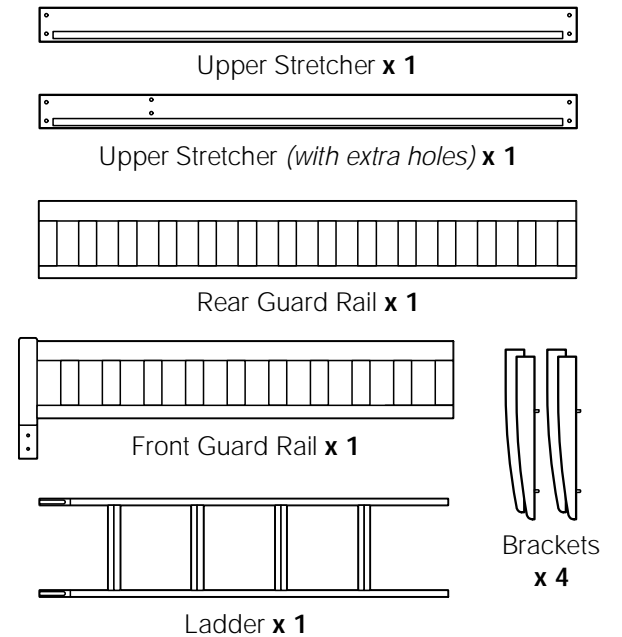

Box 4 - Slats:

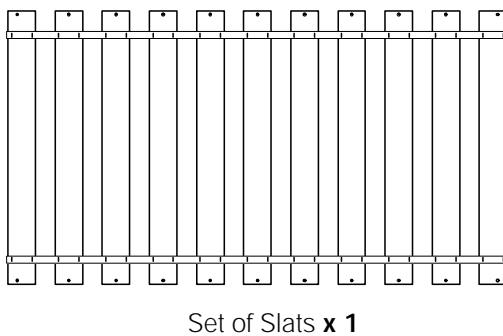

1B Hardware List: Box 1

Tools required for assembly:

- Allen Key (supplied)
- Phillips Screwdriver (not supplied)

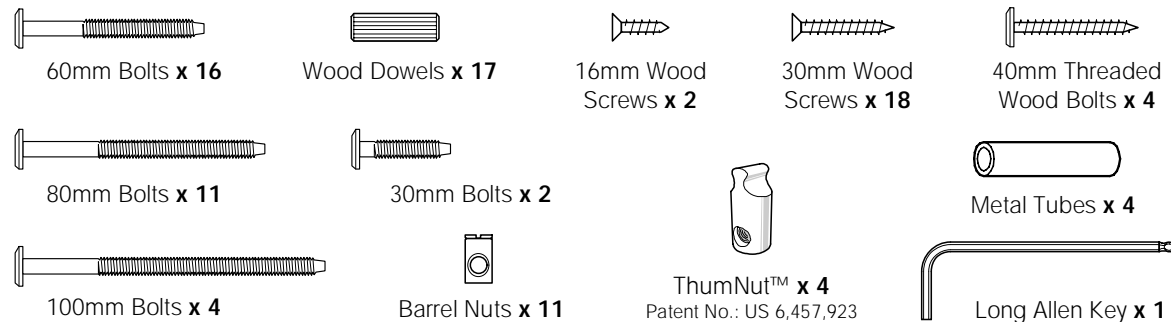

Hardware in Box 2:

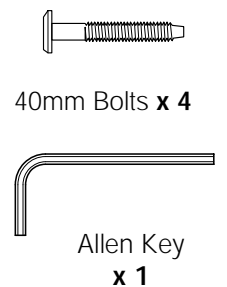

2A Attach Stretchers to Lower Frame.

Using 100mm Bolts and ThumNuts™, attach the Stretchers (from Box 2) to the Lower Bunk ends as shown below

Be sure the Stretchers are the correct way up!

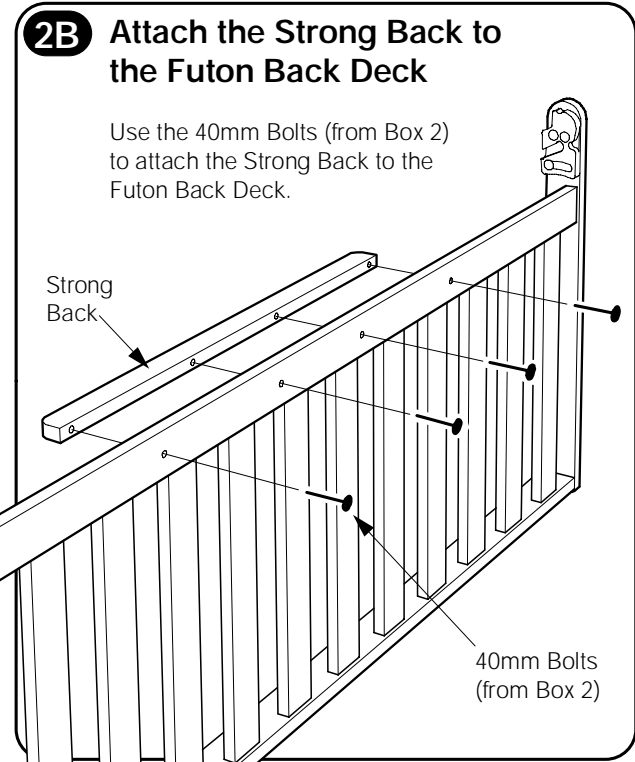
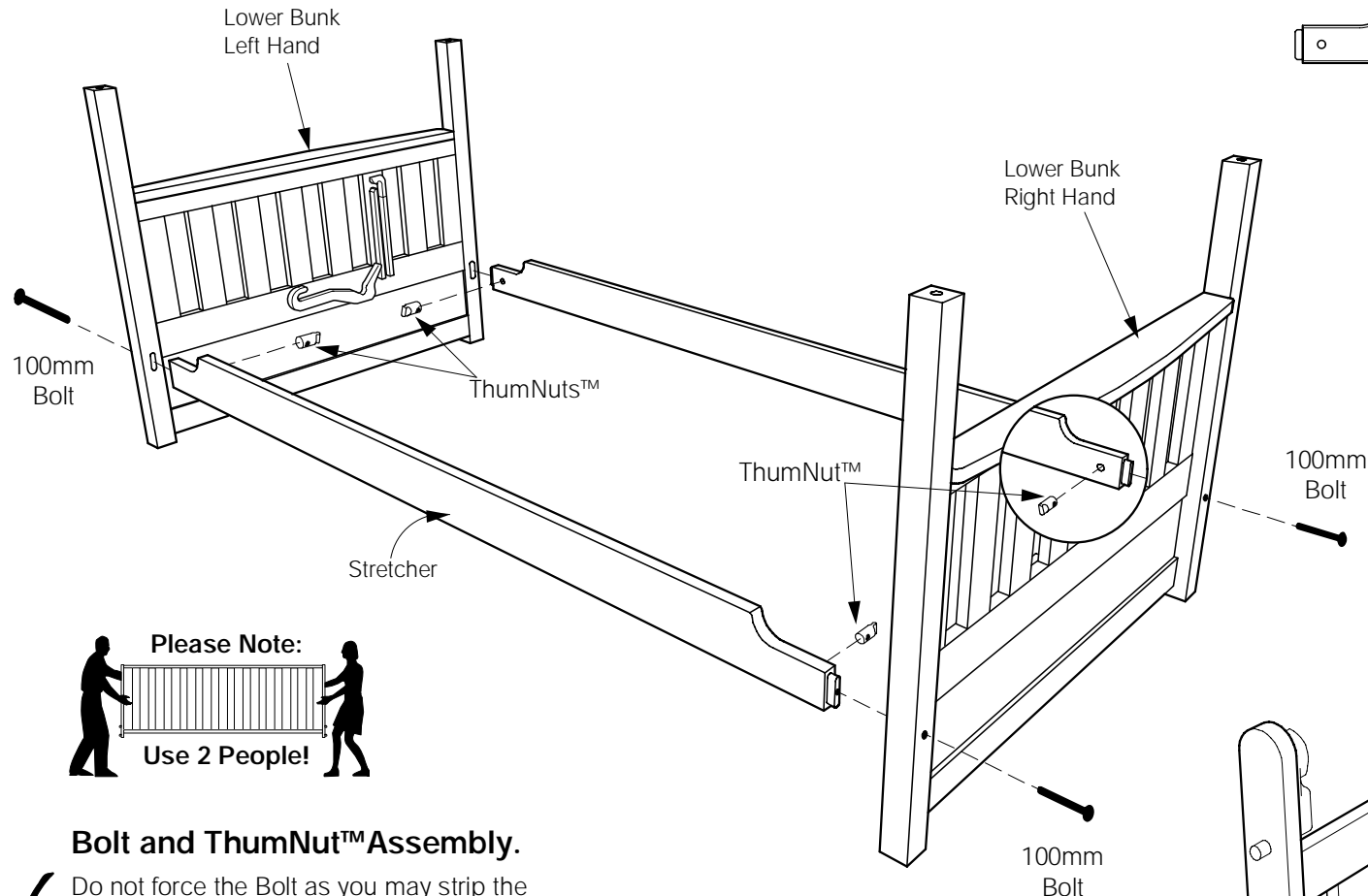

2B Attach the Strong Back to the Futon Back Deck

Use the 40mm Bolts (from Box 2) to attach the Strong Back to the Futon Back Deck.

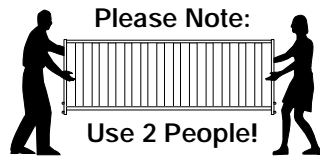

Bolt and ThumNut™ Assembly.

- ✓ Do not force the Bolt as you may strip the thread. Be sure the thread is properly started.
- ✓ Be sure the holes are free of wood chips and saw dust.

3A Carefully lift the Back Deck into position. Place the Bottom Rollers onto the back of the Rubber Sea Horse.

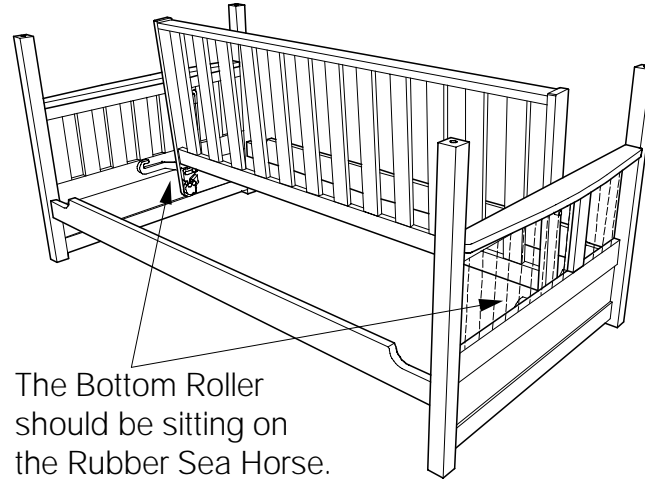
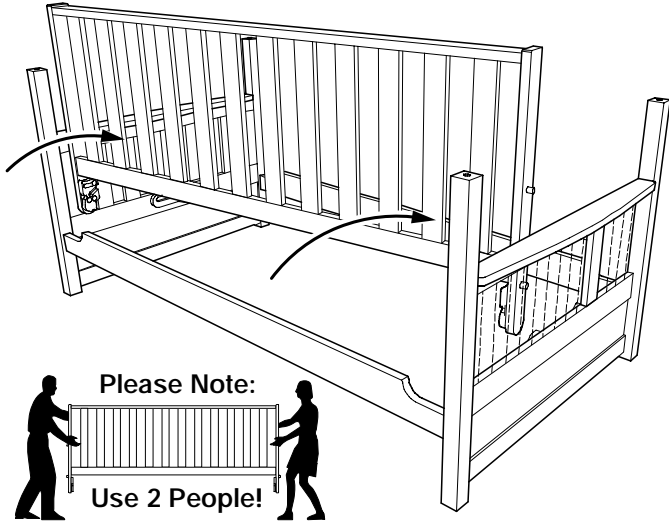

3B Rest the Top Rollers against the Leg.

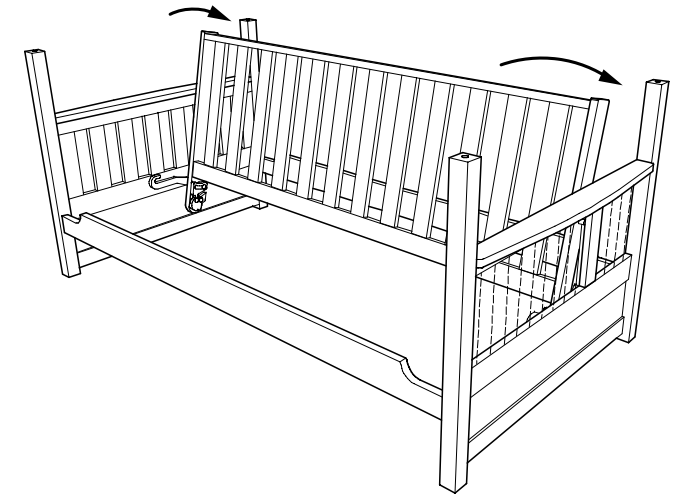

3C Gently lift the Back Deck so the Top Roller goes in under the Plastic Cap.

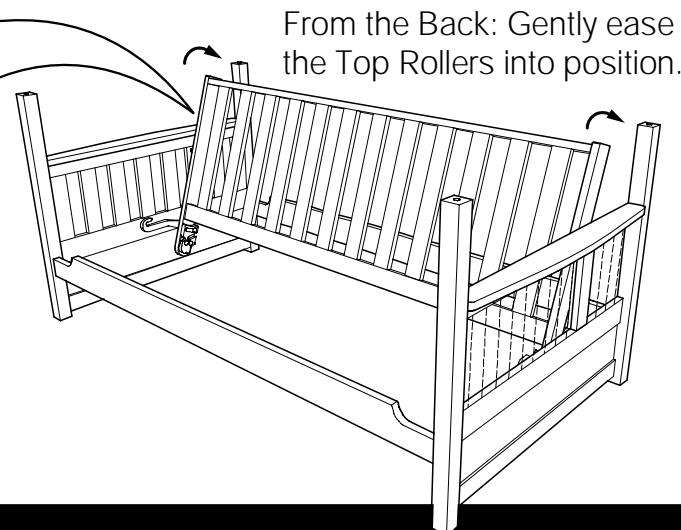
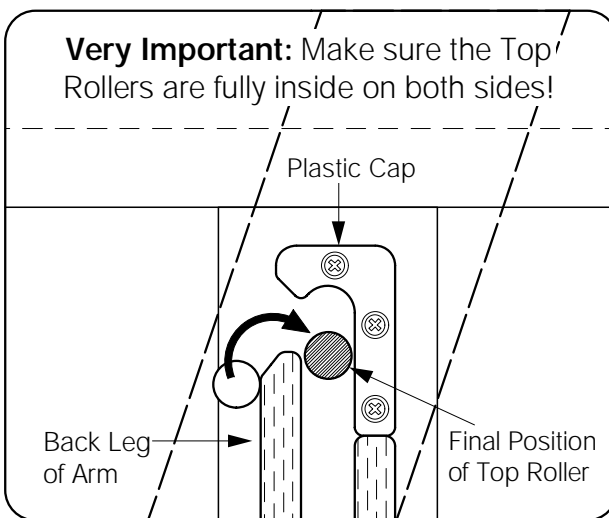

3D Gently Lower the Back down until it is lying flat.

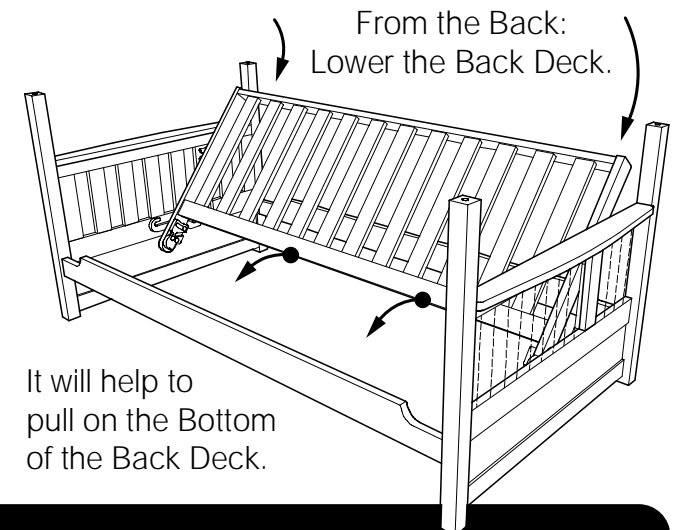

Assembly Instructions

Cinnamon FUTON BUNK BED

SHOE FITTINGS™ Gold

SF 0605

4A Hook the Seat Deck onto the Snapper.

Lift the Seat Deck in vertically, so the Pins meet with the Rubber Snapper. The head of the Snapper should fit **between both Pins**.

Remember: • The Top Pin - fits over the top,
• The Lower Pin - goes underneath.

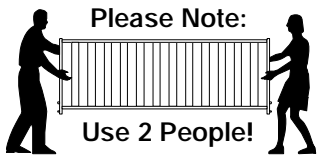
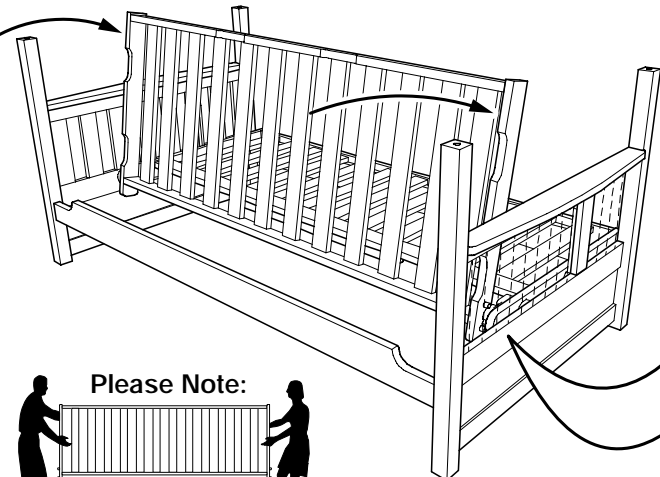
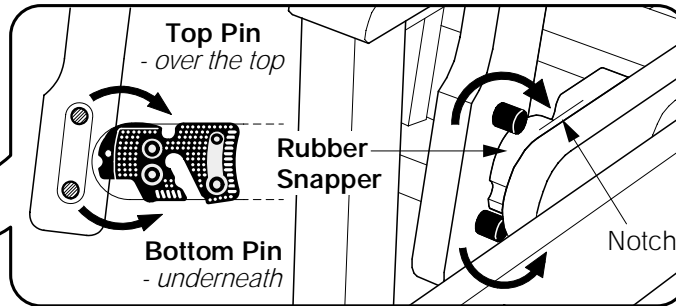

4C Push down on the Seat, and the Back will Lift.

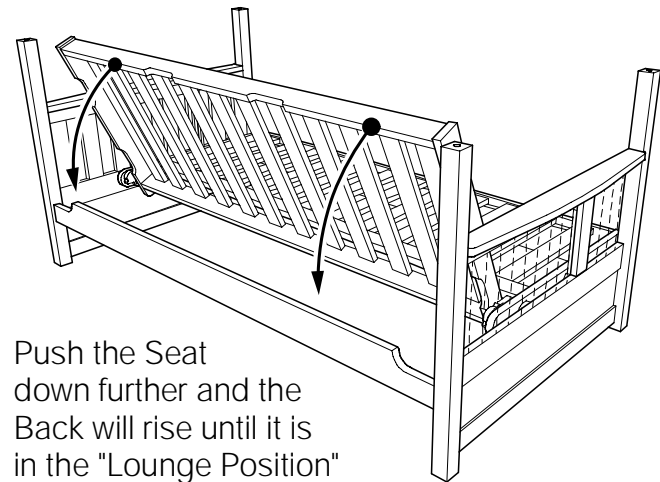

Push the Seat down further and the Back will rise until it is in the "Lounge Position"

4D This is the Lounge Position.

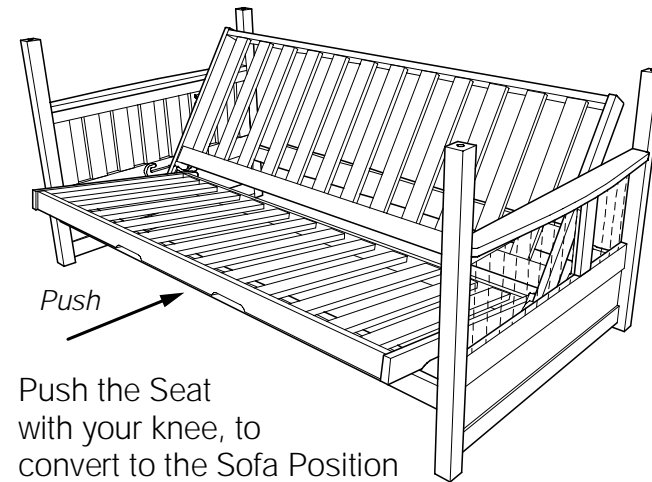

Push the Seat with your knee, to convert to the Sofa Position

4B Pull the Seat over the "Snap Point."

Put your foot on the Back and Pull Hard

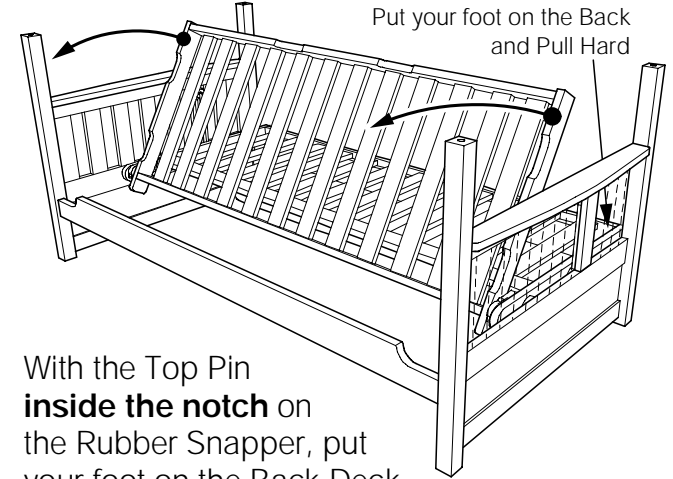

With the Top Pin **inside the notch** on the Rubber Snapper, put your foot on the Back Deck and pull the Seat over the "Snap Point"

4E This is the Sofa Position.



Add Mattress and Enjoy! See separate page for Operating Instructions.

5A Attach the Stretchers and Rear Guard Rail to the Upper Bunk.

Tap Wooden Dowels into the ends of the Stretchers and Rear Guard Rail. Using 80mm Bolts and Barrel Nuts, attach these to the Upper Bunk, carefully noting Left and Right hand sides.

Bolt and Barrel Nut Assembly.

- ✓ Do not force the Bolt as you may strip the thread. Be sure the thread is properly started.
- ✓ Be sure the holes are free of wood chips and saw dust.

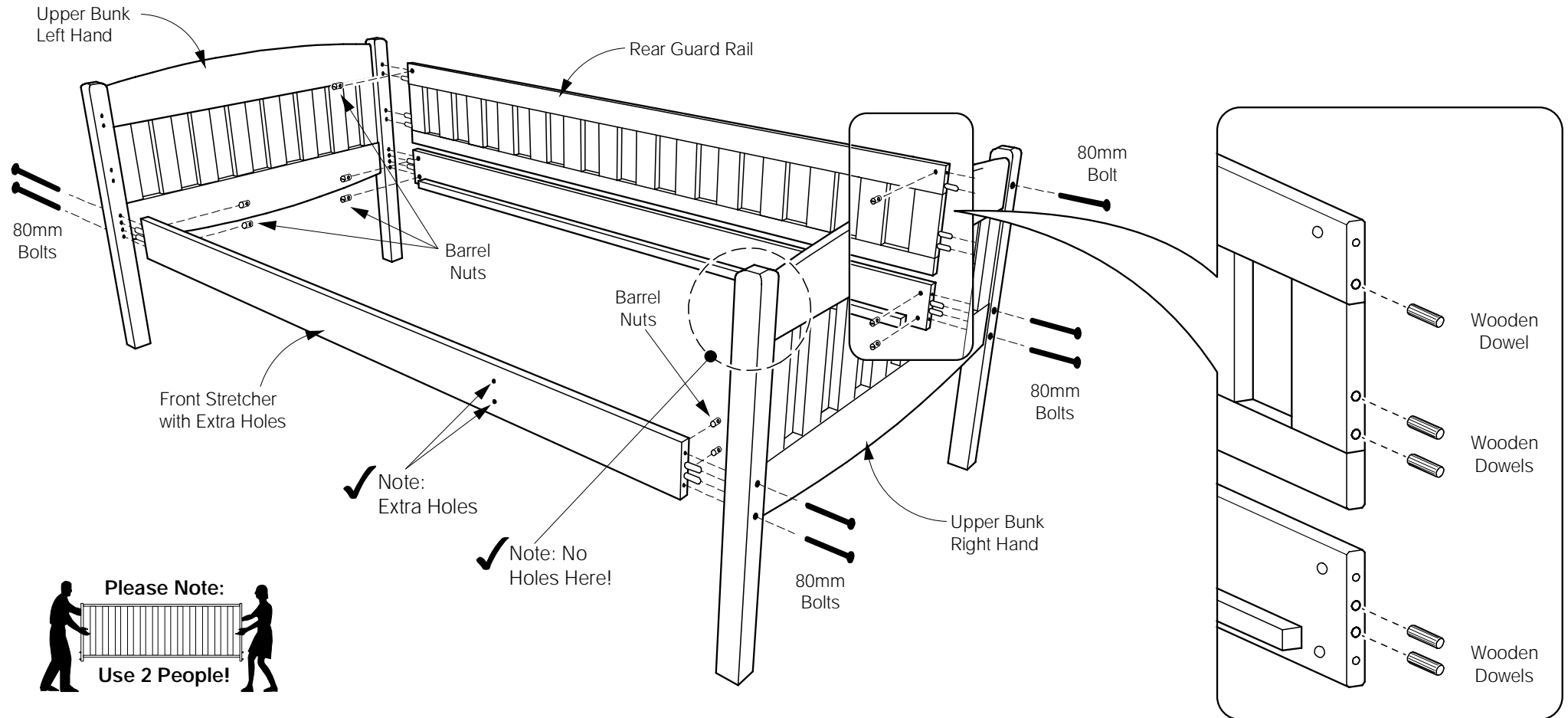

6A Attach Front Guard Rail to the Upper Bunk.

Tap Wooden Dowels into the ends of the Front Guard Rail. Use the 80mm Bolts and Barrel Nuts fix it in place. The Front Guard Rail attaches to the Stretcher using the 30mm Bolts.

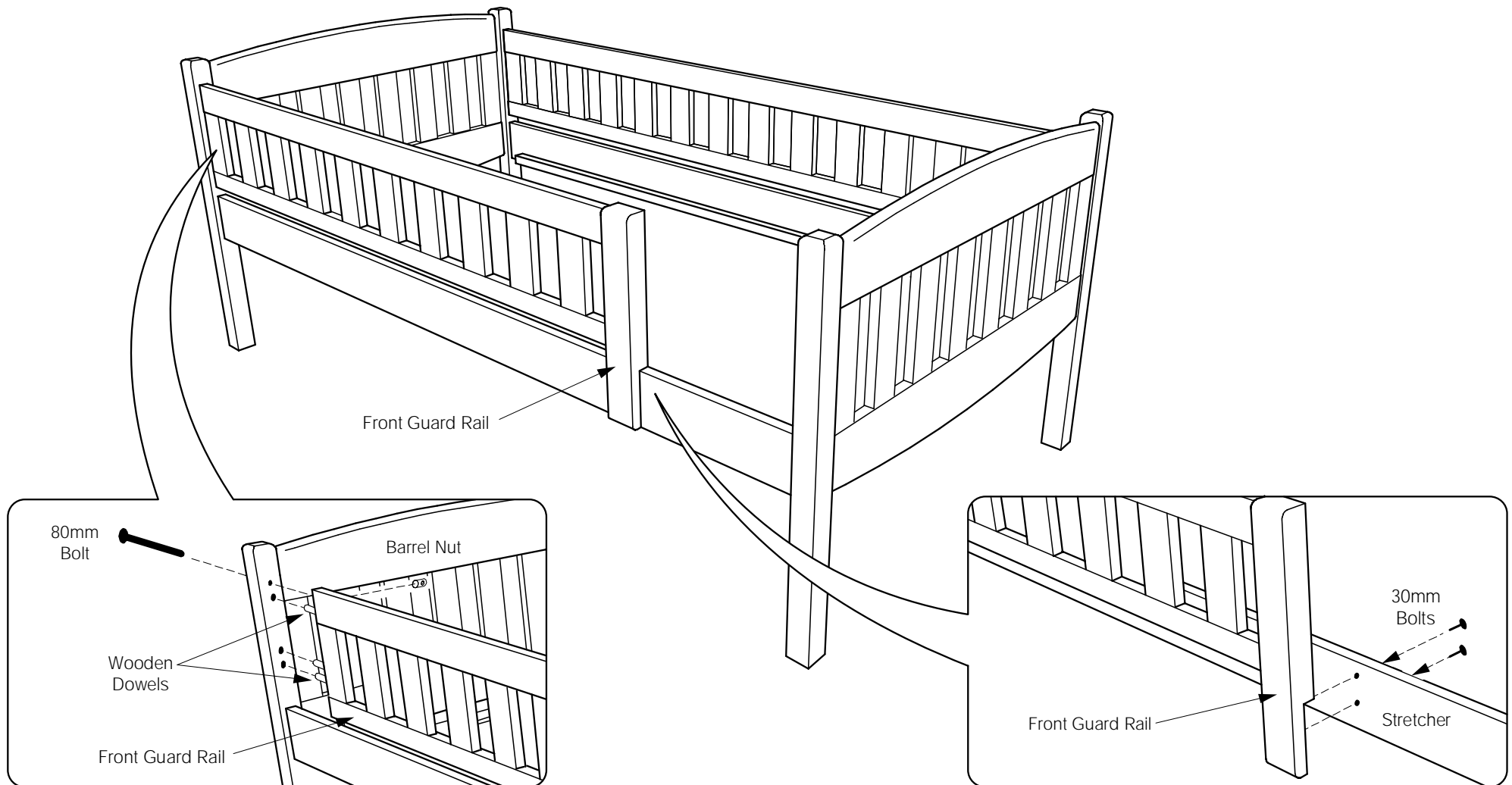

7A Bolt the Slats to the Stretchers.

Lay the Slats inside the Stretchers as shown below, and Bolt in place with the 40mm Threaded Wood Bolts (total 4 Bolts.)

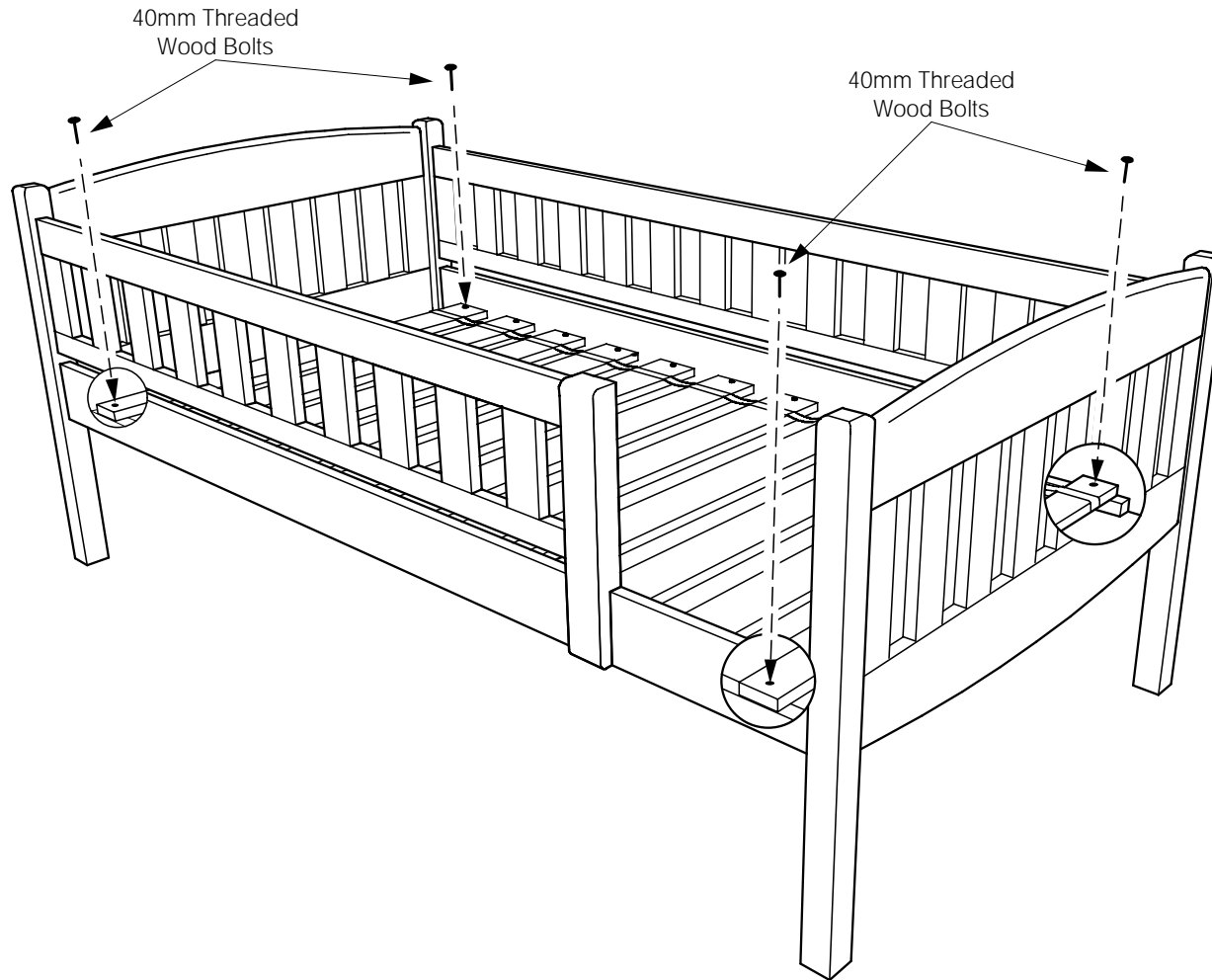

7B Fix the Remaining Slats with screws.

Use the 30mm Wood Screws to fix the remaining slats to the Stretchers (total 18 screws.) An electric screwdriver will make this much easier.

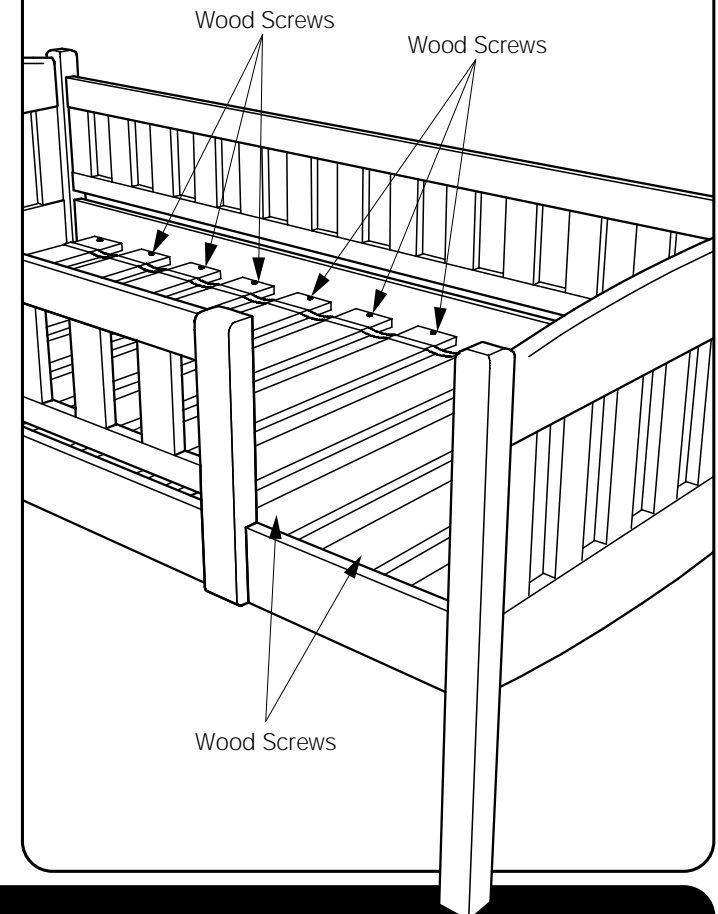

8A Fit the Upper Bunk onto the Lower Bunk.

Fit the Metal Tubes into the tops of the legs. Carefully Lift the Top Bunk onto the Lower Bunk.

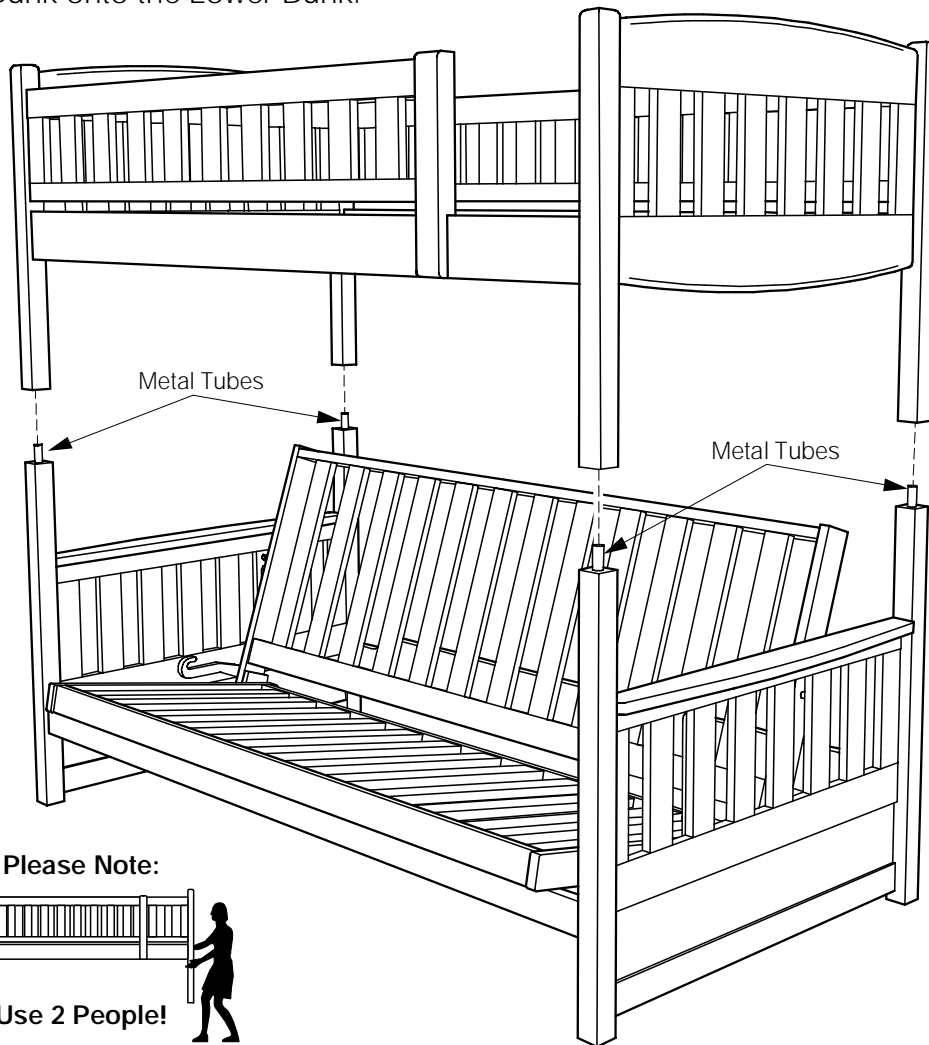

8B Fit the Brackets to the Legs.

Use the 60mm Bolts to fix the Brackets to the Legs.

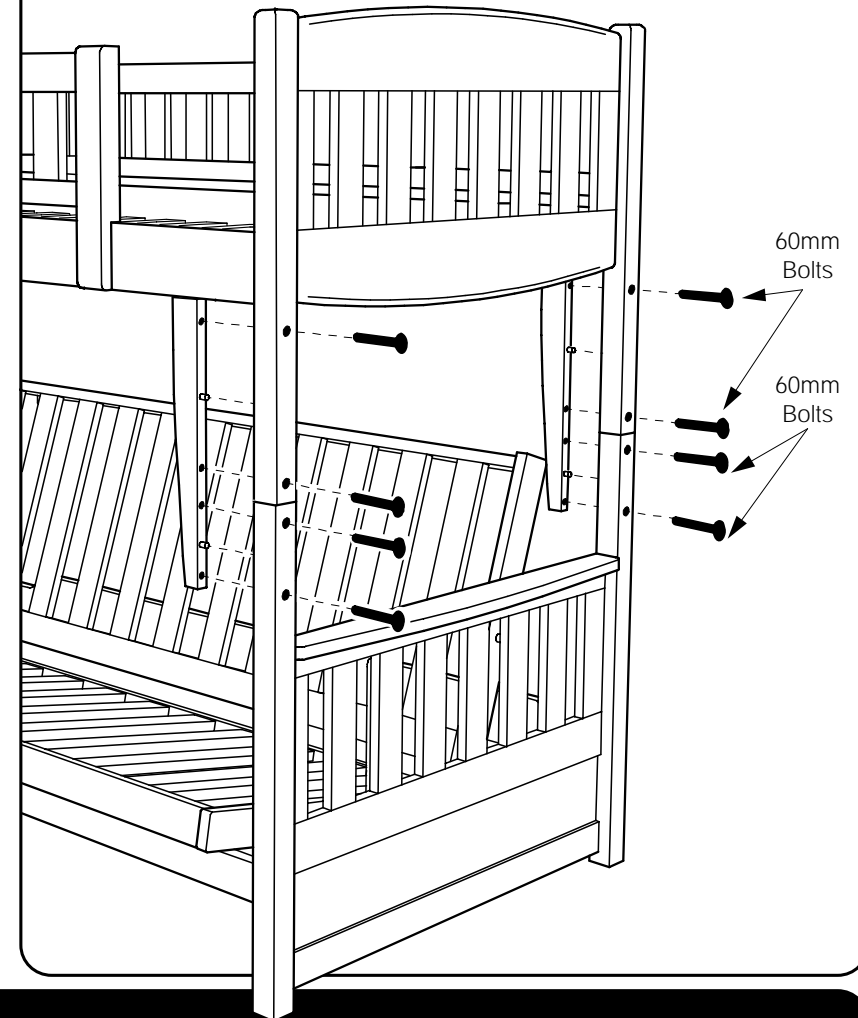

9A Attach the Ladder to the Upper Stretcher.

Finally, hook the Ladder onto the Upper Stretcher. Use the 16mm Wood Screws to fix the Ladder in place.

- Please take note of the warnings shown on page one of these instructions, printed on the carton box and on stickers on the Bunk bed.

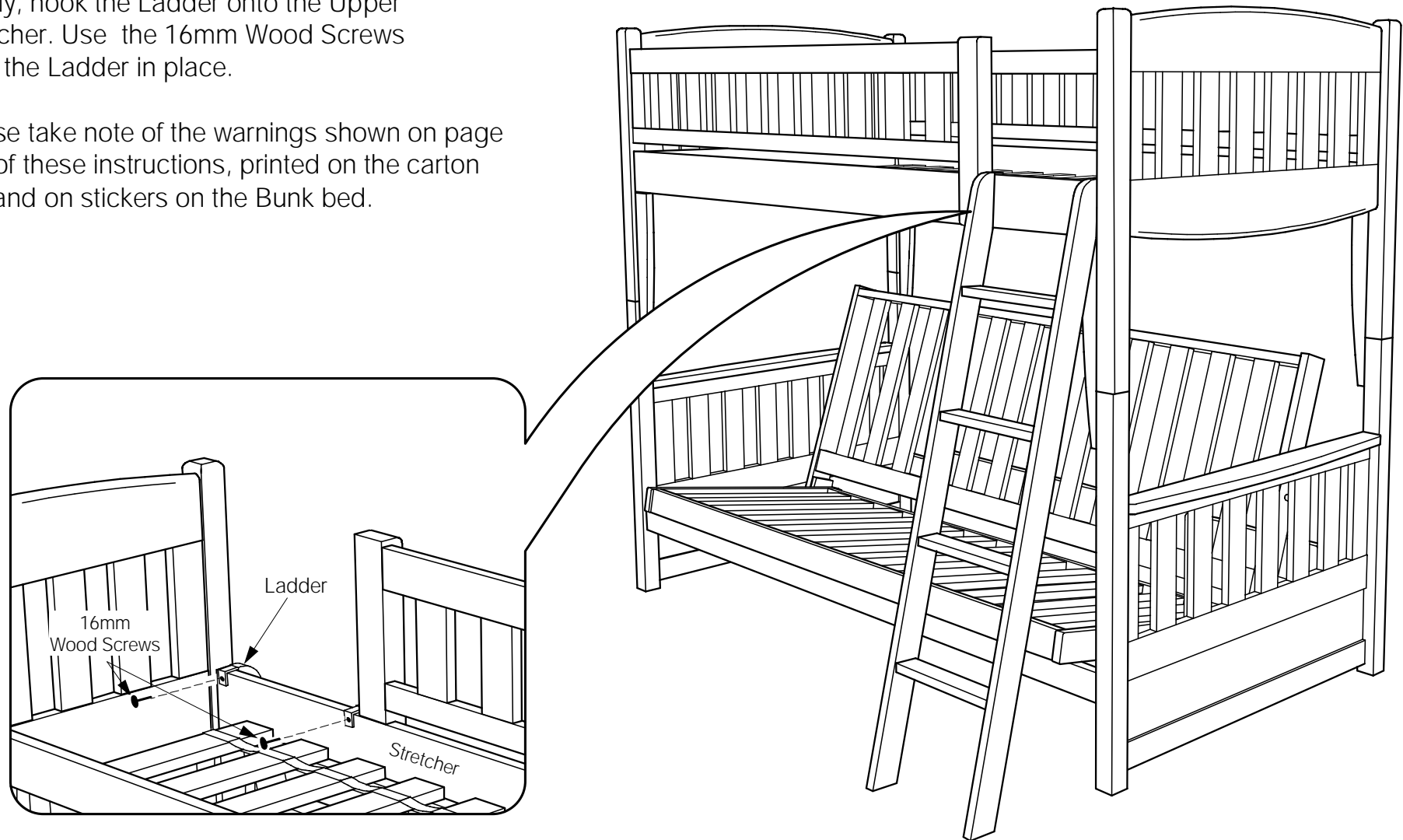

Disassembly Instructions

Cinnamon

Disassembly: How to Remove the Futon Seat

SHOE FITTINGS™ Gold

SF 0605

10A From the Bed position, lift the Seat.

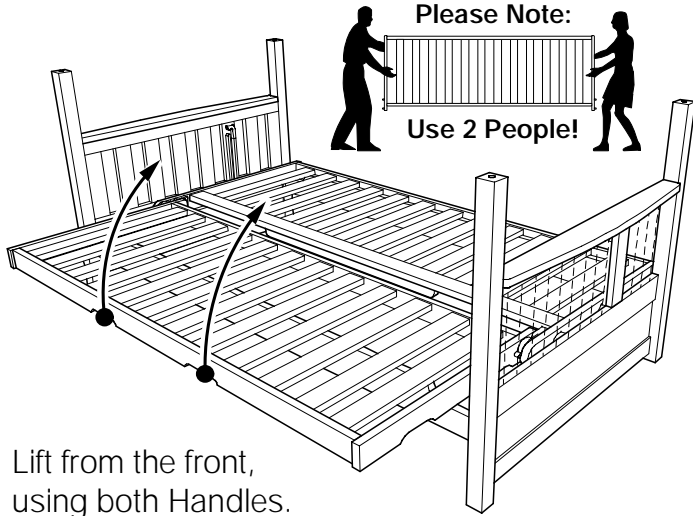

10B Lift the Seat all the way.

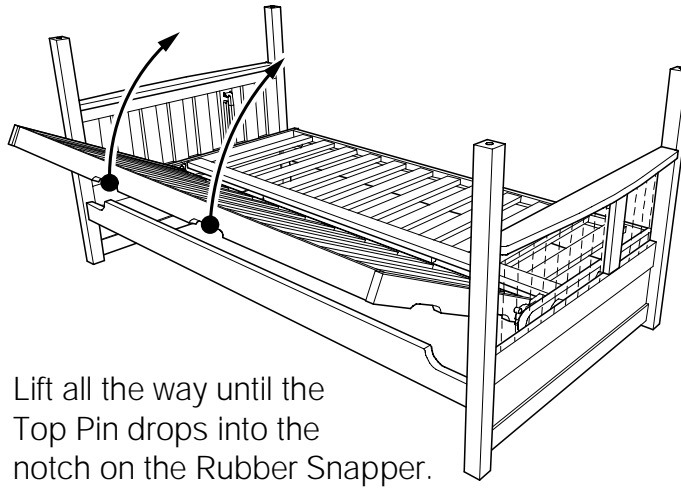

10C Push the Seat over the "Snap Point."

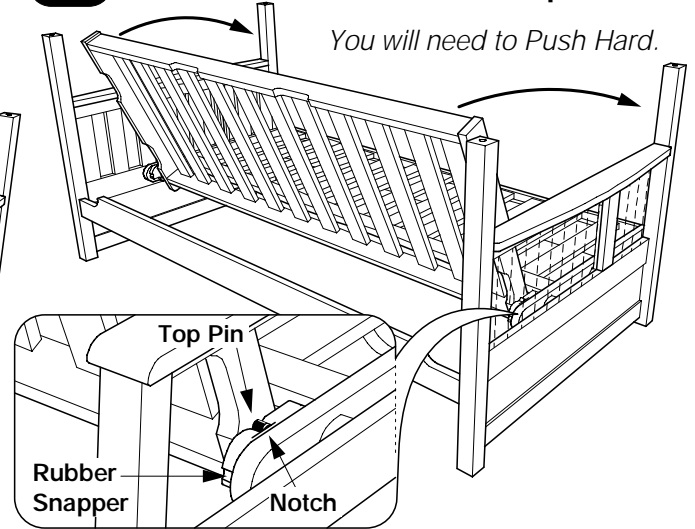

10D From the Back, lift out the Top Pin and ease the Seat Deck forward.

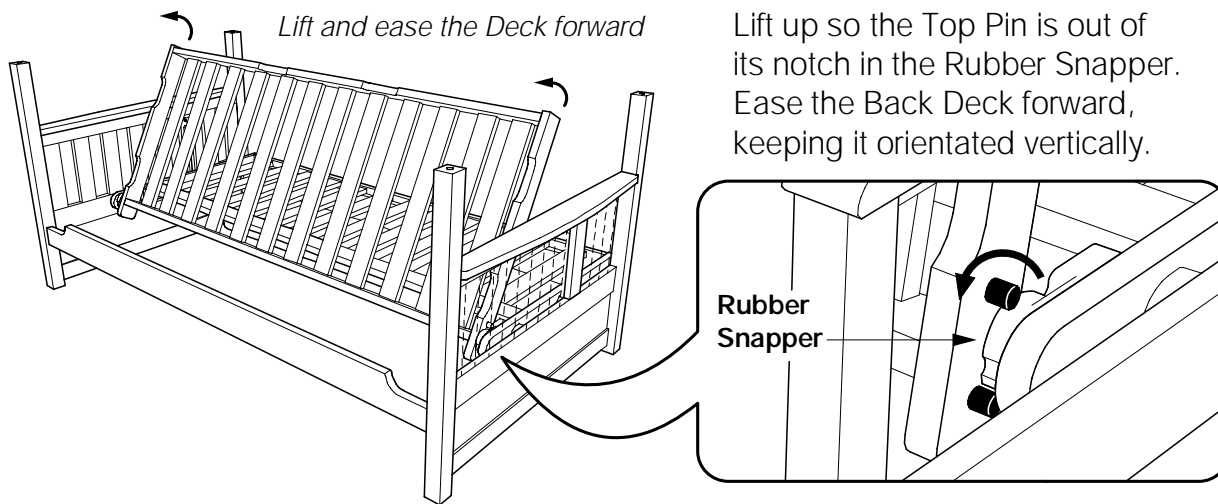

10E Lift the Seat clear of the frame.

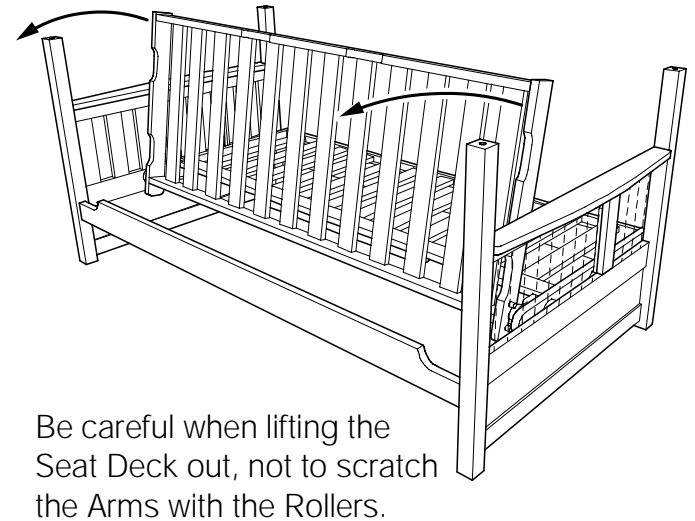

11A Lift the Back Deck up.

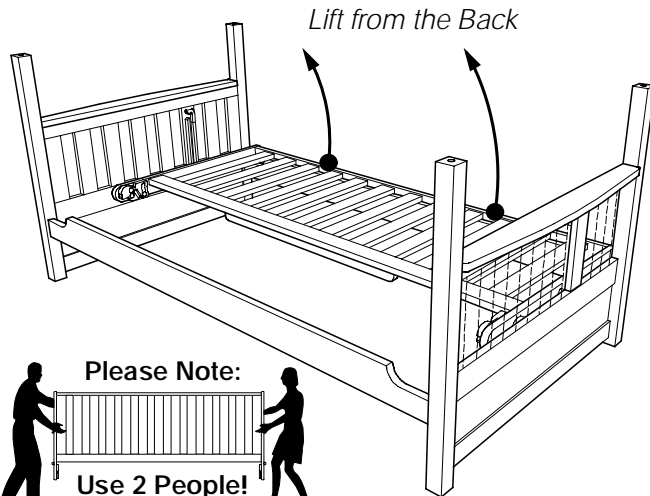

11B Lift Back Deck so the Top Roller is clear of the Back Leg.

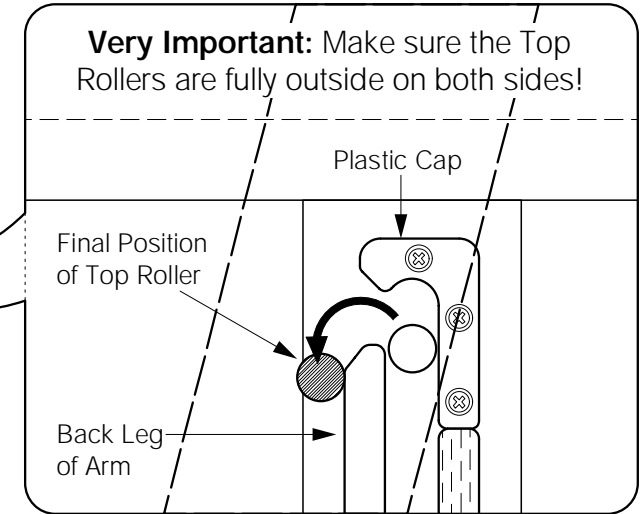

11C Push the Deck forward at the top.

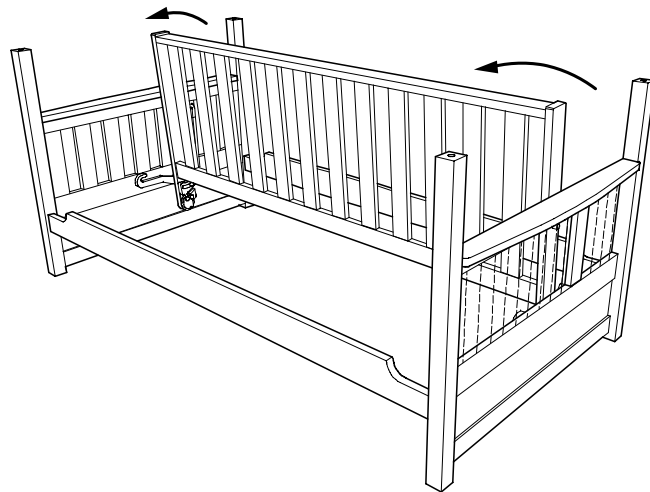

11D Lift the Back away from the Arms.

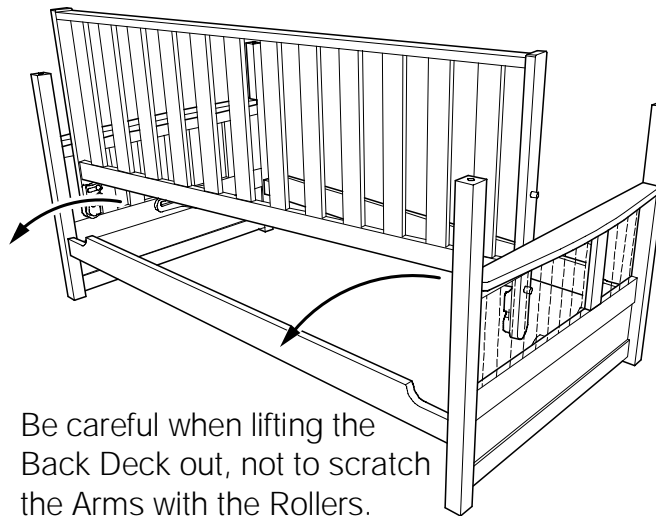

11E The frame can now be disassembled.

